

Bourdon tube pressure gauge, stainless steel

High overload safety up to the 4 times the full scale value

Models 232.36, 233.36, safety version

WIKA data sheet PM 02.15



for further approvals,
see page 5

Applications

- For occasional short-duration overpressure loads
- For gaseous and liquid aggressive media that are not highly viscous or crystallising, also in aggressive environments
- Oil and gas industry, chemical and petrochemical industry, power plants, mining, on-/offshore, environmental technology, machine building and general plant construction

Special features

- Overpressure range is indicated completely on scale
- Safety version with solid baffle wall (Solidfront) designed in compliance with the requirements of EN 837-1 and ASME B40.100
- With case filling (model 233.36) for applications with high dynamic pressure loads and vibrations
- Measuring ranges from 0 ... 0.6 bis 0 ... 40 bar [0 ... 10 to 0 ... 600 psi]



Bourdon tube pressure gauge, model 232.36, NS 100 [4"]

Description

This high-quality Bourdon tube pressure gauge has been designed specifically for the display of occasional overpressure loads. The instrument can withstand up to 4 times the full scale value for short periods, without damage.

The use of high-quality stainless steel materials and the robust design are geared to applications in the chemical and process engineering industries. Thus the instrument is suitable for liquid and gaseous media, also in aggressive environments.

Measuring ranges from 0 ... 0.6 to 0 ... 40 bar [0 ... 10 to 0 ... 600 psi] are available for a wide variety of applications.

WIKA manufactures and qualifies the pressure gauge in accordance with the standards EN 837-1 and ASME B40.100. This safety version is made up of a non-splintering window, a solid baffle wall between measuring system and dial and a blow-out back. In the event of a failure, the operator is protected at the front side, as media or components can only be ejected via the back of the case.

For harsh operating conditions (e.g. vibrations), all instruments are also available with an optional liquid filling.

Specifications

Basic information	
Standard	<ul style="list-style-type: none"> ■ EN 837-1 ■ ASME B40.100 <p>For information on the "Selection, installation, handling and operation of pressure gauges", see Technical information IN 00.05.</p>
Further version	For oxygen, oil- and grease-free
Nominal size (NS)	<ul style="list-style-type: none"> ■ Ø 100 mm [4"] ■ Ø 160 mm [6"]
Connection location	Lower mount (radial)
Window	Laminated safety glass
Case	
Design	Safety level "S3" per EN 837-1 With solid baffle wall and blow-out back Measuring ranges ≤ 0 ... 16 bar [≤ 0 ... 300 psi] with compensating valve to vent and reseal case
Material	<ul style="list-style-type: none"> ■ Stainless steel 1.4301 (304) ■ Stainless steel 1.4571 (316 Ti)
Ring	Bayonet ring, stainless steel
Mounting	<ul style="list-style-type: none"> ■ Without ■ Panel mounting flange, stainless steel ■ Panel mounting flange, polished stainless steel ■ Surface mounting lugs on the back, stainless steel
Case filling (model 233.36)	<ul style="list-style-type: none"> ■ Without ■ Glycerine ■ Glycerine-water mixture for NS 100 [4"] and 160 [6"] with measuring range ≤ 0 ... 2.5 bar [≤ 0 ... 40 psi] or for NS 63 [2 ½"] with measuring range ≤ 0 ... 4 bar [≤ 0 ... 60 psi] ■ Silicone oil
Movement	Stainless steel

Measuring element	
Type of measuring element	Bourdon tube, C-type or helical type
Material	Stainless steel 1.4404 (316L)
Leak tightness	<ul style="list-style-type: none"> ■ Helium tested, leakage rate: <math> < 5 \cdot 10^{-3}</math> mbar l/s ■ Helium tested, leakage rate: <math> < 1 \cdot 10^{-6}</math> mbar l/s

Accuracy specifications	
Accuracy class	
EN 837-1	Class 1.0 referred to the measuring span
ASME B40.100	±1 % of measuring span (grade 1A)
Temperature error	On deviation from the reference conditions at the measuring system: ≤ ±0.4 % per 10 °C [≤ ±0.4 % per 18 °F] of full scale value
Reference conditions	
Ambient temperature	+20 °C [68 °F]

Measuring ranges

Measuring range	Overload safety
bar	
0 ... 0.6	2.5
0 ... 1	4
0 ... 1.6	6
0 ... 2.5	10
0 ... 4	16
0 ... 6	25
0 ... 10	40
0 ... 16	60
0 ... 25	80
0 ... 40	100

Measuring range	Overload safety
kPa	
0 ... 60	25
0 ... 100	40
0 ... 160	60
0 ... 250	100
0 ... 400	160
0 ... 600	250
0 ... 1,000	400
0 ... 1,600	600
0 ... 2,500	800
0 ... 4,000	1,000

Measuring range	Overload safety
psi	
0 ... 10	35
0 ... 15	60
0 ... 60	230
0 ... 150	580
0 ... 250	930
0 ... 400	1,280
0 ... 600	1,500

Measuring range	Overload safety
MPa	
0 ... 0.06	0.25
0 ... 0.1	0.4
0 ... 0.16	0.6
0 ... 0.25	1
0 ... 0.4	1.6
0 ... 0.6	2.5
0 ... 1	4
0 ... 1.6	6
0 ... 2.5	8
0 ... 4.0	10

Vacuum and +/- measuring ranges

Measuring range	Overload safety
bar	
-1 ... 0	3
-1 ... +0.6	3
-1 ... +1.5	6
-1 ... +3	16
-1 ... +5	25
-1 ... +9	40
-1 ... +15	60
-1 ... +24	80

Measuring range	Overload safety
kPa	
-100 ... 0	300
-100 ... +60	300
-100 ... +150	600
-100 ... +300	1,500
-100 ... +400	2,400
-100 ... +900	4,000
-100 ... +1,500	6,000
-100 ... +2,400	8,000

Measuring range	Overload safety
psi	
-30 inHg ... 0	45
-30 inHg ... +15	45
-30 inHg ... +30	100
-30 inHg ... +60	250
-30 inHg ... +100	400
-30 inHg ... +160	600
-30 inHg ... +200	800
-30 inHg ... +300	1,000

Measuring range	Overload safety
MPa	
-0.1 ... 0	0.3
-0.1 ... +0.06	0.3
-0.1 ... +0.15	0.6
-0.1 ... +0.3	1.5
-0.1 ... +0.5	2.5
-0.1 ... +0.9	4
-0.1 ... +1.5	6
-0.1 ... +2.4	8

Further details on: Measuring ranges	
Unit	<ul style="list-style-type: none"> ■ bar ■ psi ■ kg/cm² ■ kPa ■ MPa
Vacuum resistance	<ul style="list-style-type: none"> ■ Without ■ Vacuum-resistant to -1 bar
Dial	
Scale colour	Black
Material	Aluminium
Customer-specific version	Other scales or customer-specific dials, e.g. with red mark, circular arcs or circular sectors, on request
Pointer	
Instrument pointer	Aluminium, black
Mark pointer/drag pointer	<ul style="list-style-type: none"> ■ Without ■ Red mark pointer on dial, fixed ■ Red mark pointer on window, adjustable ■ Red drag pointer on window, adjustable
Pointer stop pin	<ul style="list-style-type: none"> ■ Without ■ At 6 o'clock

Process connection	
Standard	<ul style="list-style-type: none"> ■ EN 837-1 ■ ISO 7 ■ ANSI/B1.20.1
Size	
EN 837-1	<ul style="list-style-type: none"> ■ G ½ B, male thread ■ M12 x 1.5, male thread ■ M20 x 1.5, male thread
ISO 7	<ul style="list-style-type: none"> ■ R ½, male thread
ANSI/B1.20.1	<ul style="list-style-type: none"> ■ ½ NPT, male thread
Restrictor	<ul style="list-style-type: none"> ■ Without ■ Ø 0.6 mm [0.024"], stainless steel
Material (wetted)	
Process connection	Stainless steel 1.4404 (316L)
Bourdon tube	Stainless steel 1.4404 (316L)





Other process connections on request

Operating conditions	
Medium temperature	
Unfilled instruments	-40 ... +200 °C [-40 ... +392 °F]
Instruments with glycerine filling	-20 ... +100 °C [-4 ... +212 °F]
Instruments with silicone oil filling	-40 ... +100 °C [-40 ... +212 °F]
Ambient temperature	
Unfilled instruments or with silicone oil filling	-40 ... +60 °C [-40 ... +140 °F]
Instruments with glycerine filling	-20 ... +60 °C [-4 ... +140 °F]
Pressure limitation	
Steady	End value of measuring range
Fluctuating	0.9 x end value of measuring range
Short time	The overload safety depends on the measuring range, → See page 3
Ingress protection per IEC/EN 60529	<ul style="list-style-type: none"> ■ IP65 ■ IP66

Approvals

Logo	Description	Country
-	CRN Safety (e.g. electr. safety, overpressure, ...)	Canada

Optional approvals

Logo	Description	Country
	EU declaration of conformity ATEX directive Hazardous areas - Ex h Gas II 2G Ex h IIC T6 ... T1 Gb X Dust II 2D Ex h IIIC T85°C ... T450°C Db X	European Union
	EAC Hazardous areas	Eurasian Economic Community
	PAC Russia Metrology, measurement technology	Russia
	PAC Kazakhstan Metrology, measurement technology	Kazakhstan
-	MChS Permission for commissioning	Kazakhstan
	PAC Belarus Metrology, measurement technology	Belarus
-	PAC Ukraine Metrology, measurement technology	Ukraine
-	CPA Metrology, measurement technology	China

Manufacturer's information and certificates

Logo	Description
-	Pressure equipment directive (PED) for maximum allowable pressure PS ≤ 200 bar
-	Suitability of wetted materials for drinking water in accordance with the European 4MS initiative

Certificates (option)

Certificates	
Certificates	<ul style="list-style-type: none"> ■ 2.2 test report per EN 10204 (e.g. state-of-the-art manufacturing, indication accuracy) ■ 3.1 inspection certificate per EN 10204 (e.g. material proof for wetted metal parts, indication accuracy) ■ PCA calibration certificate, traceable and accredited in accordance with ISO/IEC 17025 ■ Calibration certificate by a national accreditation body, traceable and accredited in accordance with ISO/IEC 17025 on request
Recommended calibration interval	1 year (dependent on conditions of use)

→ For approvals and certificates, see website

Dimensions in mm [in]

Lower mount (radial)

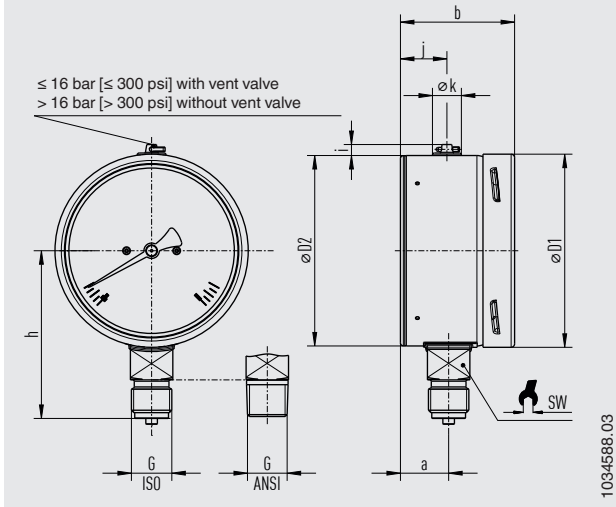

Process connection with thread per EN 837-1

NS	G	Dimensions in mm [in]								
		$h \pm 1$ [0.04]	a	b	D1	D2	i	j	k	SW
100 [4"]	G ½ B	87 [3.43]	25 [0.98]	59.5 [2.34]	100 [3.94]	100 [3.94]	6 [0.24]	24 [0.94]	15 [0.59]	22 [0.87]
	M12 x 1.5	80 [3.15]								
	M20 x 1.5	87 [3.43]								
160 [6"]	G ½ B	118 [4.65]	27 [1.06] ¹⁾	65 [2.56] ²⁾	159 [6.26]	159 [6.26]	6 [0.24]	18.5 [0.73]	15 [0.59]	22 [0.87]
	M12 x 1.5	111 [4.37]								
	M20 x 1.5	118 [4.65]								

Process connection with thread per ISO 7









NS	G	Dimensions in mm [in]								
		$h \pm 1$ [0.04]	a	b	D1	D2	i	j	k	SW
100 [4"]	R ½	86 [3.39]	25 [0.98]	59.5 [2.34]	100 [3.94]	100 [3.94]	6 [0.24]	24 [0.94]	15 [0.59]	22 [0.87]
160 [6"]	R ½	117 [4.61]	27 [1.06]	65 [2.56]	159 [6.26]	159 [6.26]	6 [0.24]	18.5 [0.73]	15 [0.59]	22 [0.87]

Process connection with thread per ANSI/B1.20.1

NS	G	Dimensions in mm [in]								
		$h \pm 1$ [0.04]	a	b	D1	D2	i	j	k	SW
100 [4"]	½ NPT	86 [3.39]	25 [0.98]	59.5 [2.34]	100 [3.94]	100 [3.94]	6 [0.24]	24 [0.94]	15 [0.59]	22 [0.87]
160 [6"]	½ NPT	117 [4.61]	27 [1.06]	65 [2.56]	159 [6.26]	159 [6.26]	6 [0.24]	18.5 [0.73]	15 [0.59]	22 [0.87]

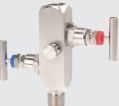
NS	Weight	
	Model 232.36	Model 233.36
100 [4"]	approx. 0.65 kg [1.43 lb]	approx. 1.08 kg [2.38 lb]
160 [6"]	approx. 1.30 kg [2.87 lb]	approx. 2.34 kg [4.94 lb]

Accessories and spare parts for models 232.36 and 233.36

Model	Description
	910.17 Sealings → See data sheet AC 09.08
	910.15 Syphons → See data sheet AC 09.06
	910.13 Overpressure protector → See data sheet AC 09.04
	IV10, IV11 Needle valve and multiport valve → See data sheet AC 09.22
	IV20, IV21 Block-and-bleed valve → See data sheet AC 09.19
	IVM Monoflange, process and instrument version → See data sheet AC 09.17
	BV Ball valve, process and instrument version → See data sheet AC 09.28
	IBF2, IBF3 Monoblock with flange connection → See data sheet AC 09.25

Ordering information

Model / Nominal size / Measuring range / Process connection / Connection location / Options

© 02/1995 WIKA Alexander Wiegand SE & Co. KG, all rights reserved.
 The specifications given in this document represent the state of engineering at the time of publishing.
 We reserve the right to make modifications to the specifications and materials.

