



Simulate battery cells with this flexible, high-precision generator.

- Consolidates 12 power supplies, electronic loads, and DMMs into a single unit.
- Delivers world-class voltage output precision and voltage/current measurement precision.
- Provides safe, simple battery cell simulation functionality.
- Provides simulation and control functionality via an included computer application.
- Delivers peace of mind thanks to reliable support from providers of international standard-compliant calibration services.

SS7081-50: A flexible generator with high-precision output and high-precision measurement capability

The Battery Cell Voltage Generator SS7081-50 incorporates DC power supplies, voltmeters and ammeters, and simulated relays for 12 battery cells into a single piece of hardware. Voltages of up to 1000 V are supported when you expand the SS7081-50 and connecting channels in series.

Power supplies, electronic loads, and DMMs for 12 cells

- Simulate cell behavior for individual channels with 12 channels per unit.
- Build a serially connected cell environment with a voltage of up to 1000 V (max. 17 units).

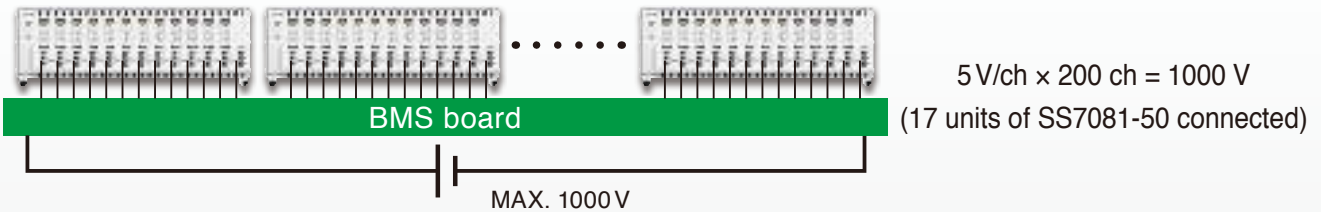

World-class voltage output precision and voltage/current measurement precision

- Simulate cell behavior with voltage output of 0 V to 5 V.
- Perform cell balancing with a 2-quadrant voltage of -1 A to 1 A.

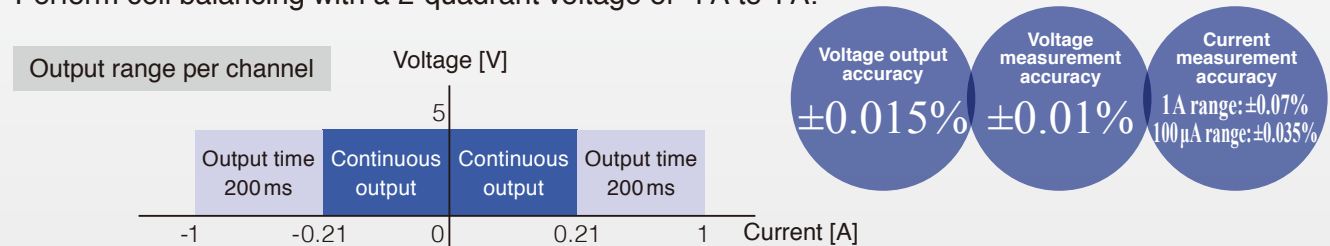

High-precision minuscule-current measurement: 100 μ A range

- Check current consumption (dark current) with the BMS power supply in the “off” state.
- Check current consumption (standby current) with the BMS in the standby state.

Simple, safe simulation functionality

- Simulate voltage anomalies, shorts between cell terminals, and broken connections between the BMS board and cells using short-circuit and broken-connection relays that are located between cell connection terminals and between the BMS and cells.

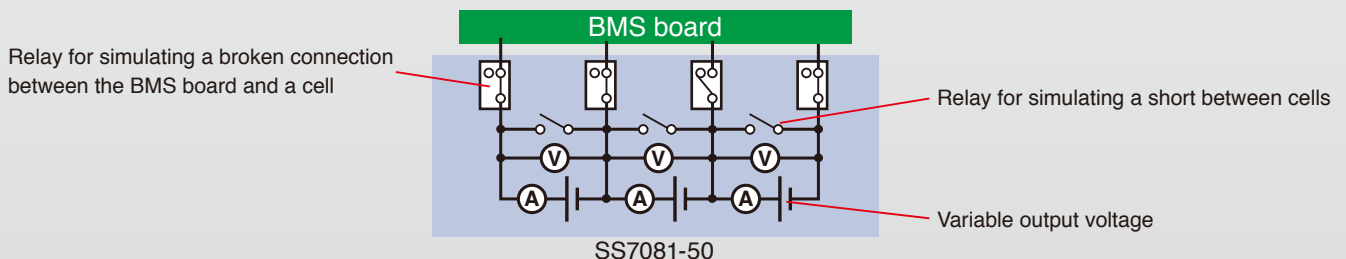

Peace of mind thanks to reliable support from providers of international standard-compliant calibration services

- Obtain certificates and associated documentation from ISO/IEC 17025-certified laboratories and calibration service providers.

*Calibration is performed for customer-specified calibration points within the scope of certification. Calibration cannot be performed across the full scope of the product specifications.



Battery management systems (BMSs): An essential part of secondary battery operation

What's a BMS?

In order to use a secondary battery safely and efficiently, it's necessary to monitor and control the condition of the battery's cells in real time (including capacity; voltage, current, and power; temperature; charge/discharge state; and balancing between cells). Battery management systems (BMSs) perform these monitoring and control tasks.

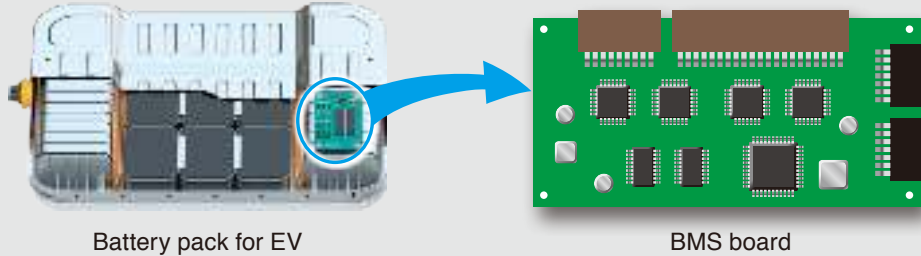

BMS structure and the need for high-precision BMS

The efficiency with which secondary batteries operate varies significantly with the performance of the BMS. Consequently, reliability evaluation testing plays an important role in ensuring BMS quality.

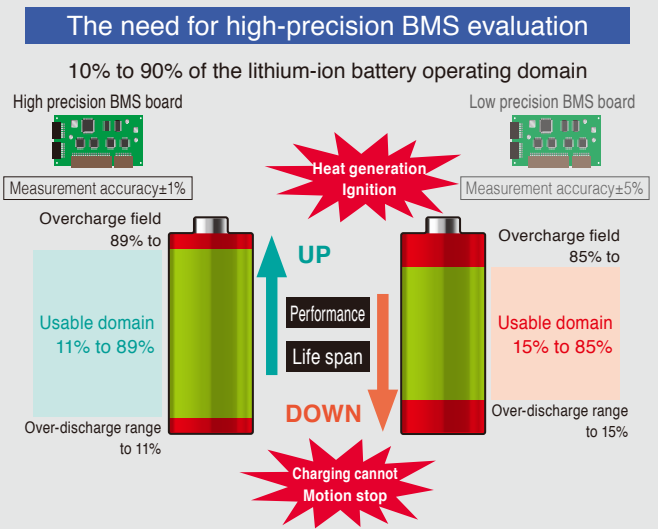
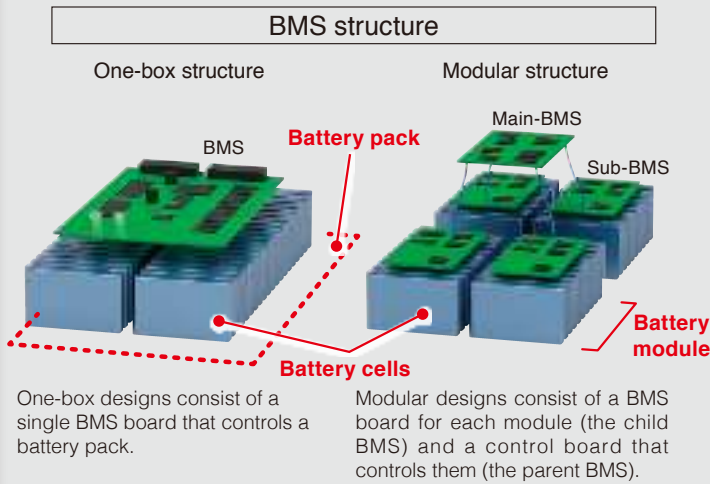

BMS reliability evaluation testing

Higher-reliability testing is necessary since insufficient BMS reliability can lead to serious accidents or failures caused by batteries. However, testing that uses actual batteries suffers from the following issues:

- **Safety:** Battery handling demands caution (due to the risk of electrolyte leaks, heating, fire, ruptures, and electric shock).
- **Reliability:** Performance varies with factors such as individual differences and deterioration.
- **Malfunction detection:** It's difficult to reproduce conditions such as the states under which malfunctions occur.

As a result, there's a need for evaluation testing that is safer and more precise than approaches that use actual batteries and individual power supplies.

The **Battery Cell Voltage Generator SS7081-50** lets you resolve issues associated with BMS reliability evaluation testing by building an environment to simulate the battery voltages of 12 cells with a single piece of hardware.

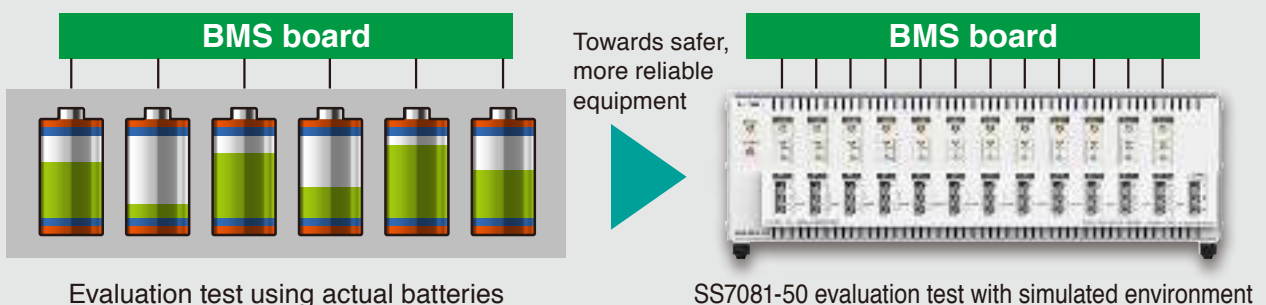

Simulation function using the included*

Simulation using a sample program

The SS7081-50 can be controlled using the included computer application. For example, measurement data obtained using the Battery Impedance Meter BT4560, Chemical Impedance Analyzer IM3590, or other instruments can be used to simulate the operation of battery cells during charging and discharging.



SS7081-50



Easily build your own system to control the SS7081-50 on site, or use the bundled PC application.

Charge/discharge simulation

SOC can be estimated based on current integrated value versus voltage characteristics and battery capacity versus battery voltage characteristics.

These SOC estimates can be used to check whether the SOC estimation program implemented by the BMS microcontroller is operating properly.

Observed parameter values obtained in advance using a charge/discharge testing system are utilized to perform the simulation. Measured values are fed into the SS7081-50. Operation can be made to approach the actual operating environment by automatically varying charge and discharge current values.

Two simulation methods: Linear interpolation and curve-fitting

These methods are used to approximate the characteristics curves since the slope of the output voltage curve changes abruptly when there are few data points, making it impossible for the SS7081-50 to generate smooth discharge output.

Linear interpolation method

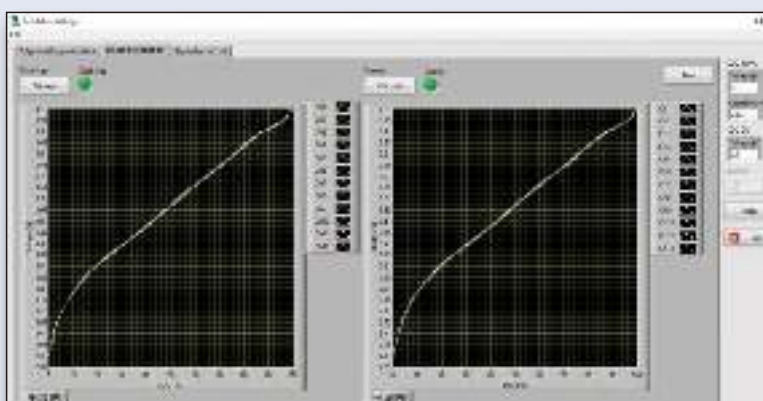

Settings screen: Entering different data for charging and discharging

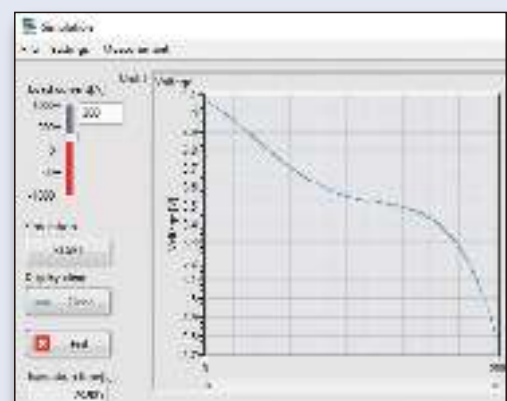

Results of voltage simulation between batteries

*Operating conditions: Instrument and computer application must both be Ver. 2.50 or later.

Charge/discharge simulation

Curve-fitting method

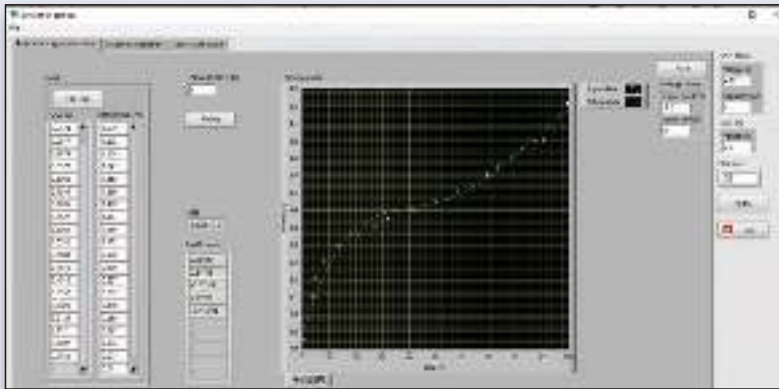

Settings screen: Entering shared data for charging and discharging and approximating it with a polynomial

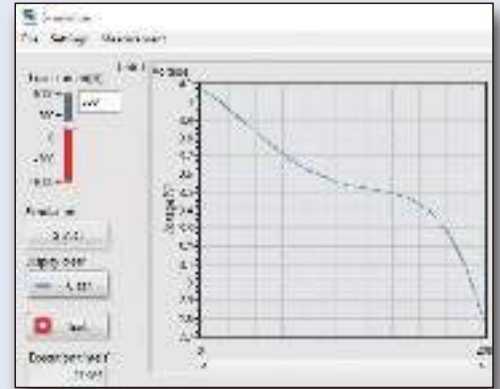

Results of voltage simulation between batteries

Transient Response Simulation with Equivalent Circuit Parameters

This function allows you to check the SOC and SOH estimation programs implemented in the BMS microcontroller, and to confirm the results of the SOC and SOH calculations estimated by the BMS side for the equivalent circuit model input to the SS7081-50. We will also check that the BMS does not operate abnormally.

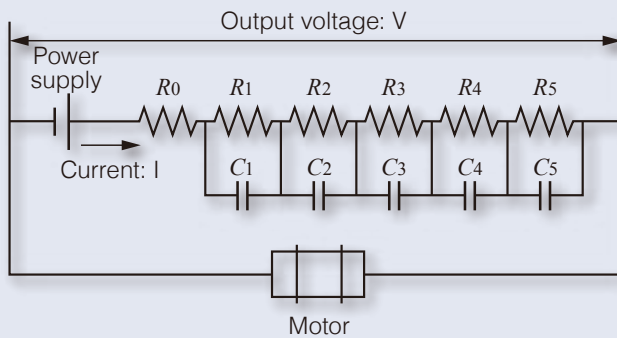

Battery equivalent circuit



(Example)
BATTERY IMPEDANCE METER BT4560

Measured values can be used (requires calculations to be performed in advance using ZView® equivalent circuit software from Scribner Associates Inc.).



Settings screen: Setting internal impedance values for each channel

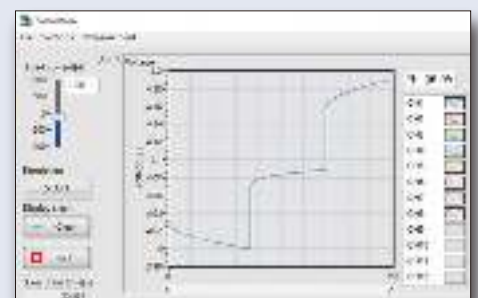

Results of battery transient response simulation

SS7081-50 applications

Support for battery HILS*¹ test environments

*1 HILS: Hardware-In-the-Loop-Simulation

BMS development is transitioning from physical evaluation to virtual simulation evaluation, or HILS. The SS7081-50 can be controlled using TCP-IP (LAN) communications commands from an HILS control computer*². (The SS7081-50 ships standard with a LabVIEW driver)

*2 Please contact Hioki if you're interested in CAN communications.

Additionally, the SS7081-50 can be combined with the Memory HiCorder MR8740T and VIR Generator Unit U8794 to enable temperature simulation testing*³.

*3 Please contact Hioki if you're interested in this capability.

Battery HILS test system architecture

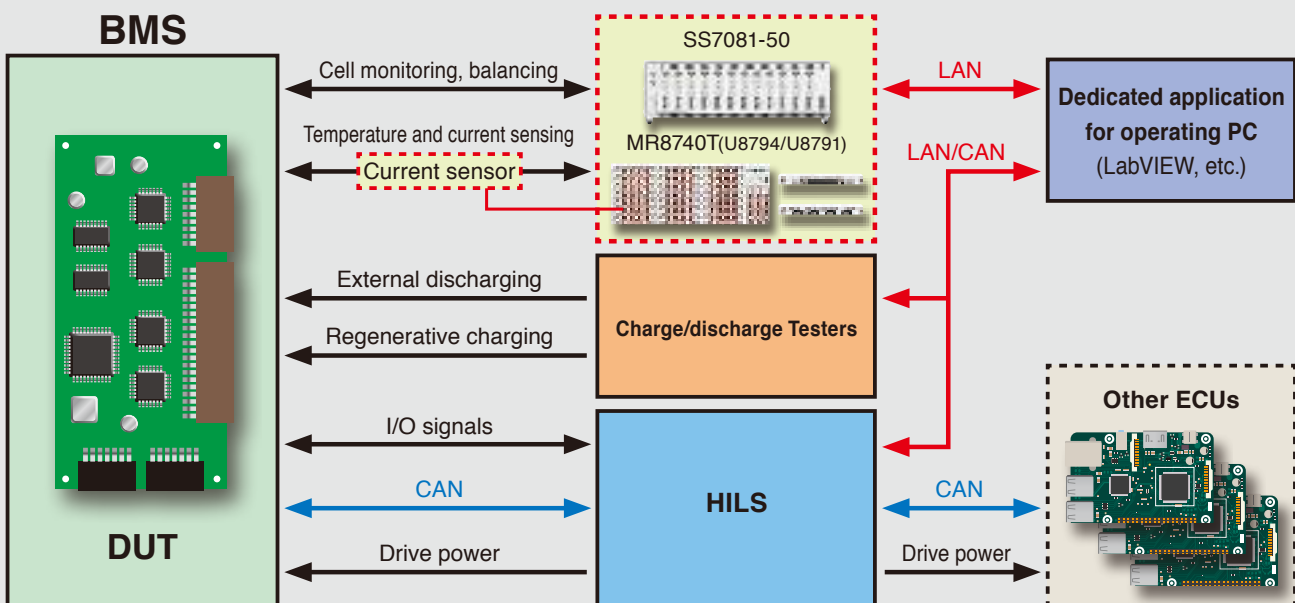
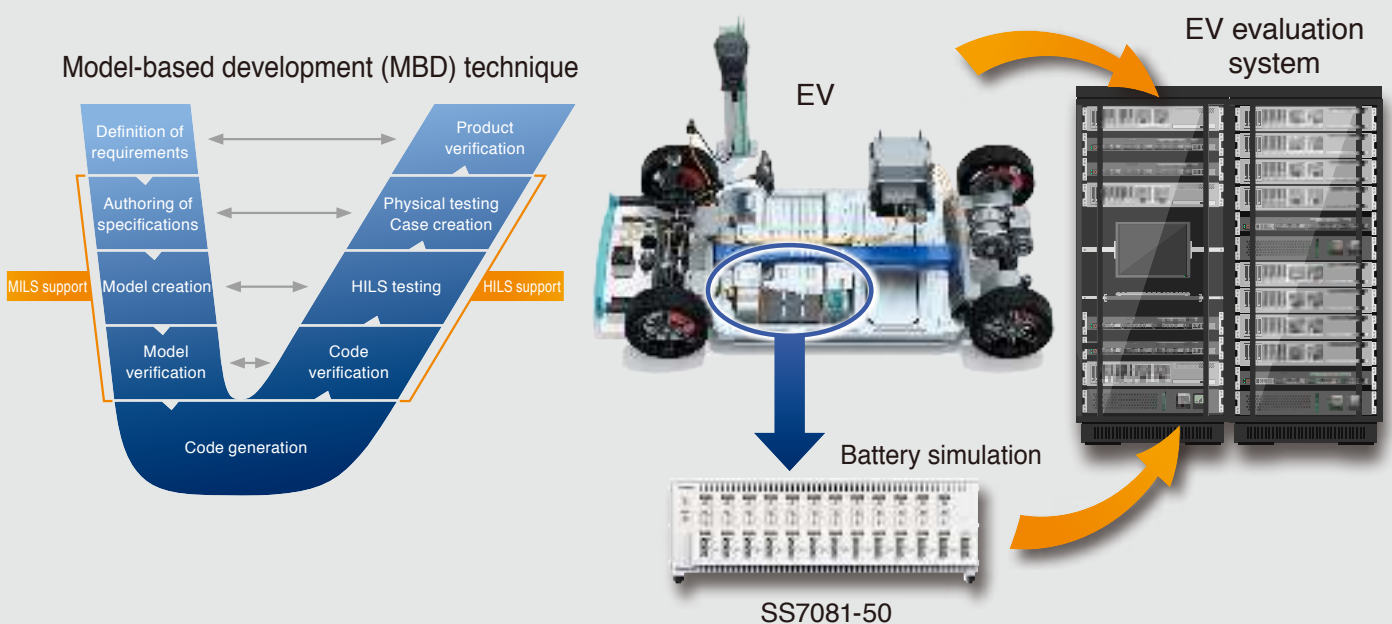

Illustration of embedding in a battery HILS EV evaluation system



Standalone reliability testing

Implementing a simple, safe, high-precision testing environment

Issues with conventional BMS functional evaluation environments

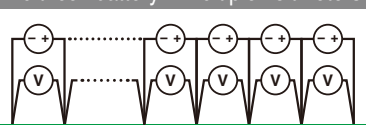
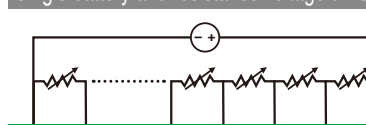
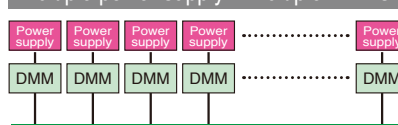
<p>Multi-cell battery + multiple voltmeters</p>  <p>BMS board</p> <ul style="list-style-type: none"> ● Battery handling demands caution. ● Battery quality exhibits variability. ● Degraded battery performance has a greater impact on measurement reproducibility. ● It's difficult to create verification operating conditions. 	<p>Single battery and resistance voltage division</p>  <p>BMS board</p> <ul style="list-style-type: none"> ● Battery handling demands caution. ● Measurement precision suffers due to resistance value variability. ● The resistance divider has a negative effect on the overall effect when the resistance is variable. ● It's difficult to create verification operating conditions. 	<p>Multiple power supply + multiple DMMs</p>  <p>BMS board</p> <ul style="list-style-type: none"> ● The cost of the number of channels is high. ● Complicated control and wiring processes for each device. ● Extensive maintenance work for each device.
---	--	---

Resolve all these issues



with the **BATTERY CELL VOLTAGE GENERATOR SS7081-50**

Supports BMS used in various fields



EV and fuel cell vehicles



EV trucks and EV buses



Heavy machinery



Small Mobility



Robot



Emergency power supply



Energy Storage System

Specifications (Accuracy guaranteed for 1 year)

Number of channels	12	
Maximum in-series connections	In-series connections of instrument up to and including a maximum in-series output voltage of 1000 V	
Output range	DC voltage	0.0000 V to 5.0250 V (set independently for all channels)
	Maximum output current	±1.00000 A (set independently for all channels) Continuous output: -210 mA to 210 mA Continuous output of currents greater than 210 mA or less than -210 mA is subject to limitations*. *Continuous output limitations Max. output time: 200 ms Time to next output (reference value): If outputting 1 A at 5 V for 200 ms, 5 s
Measurement range	DC voltage	-0.00100 V to 5.10000 V
	DC current (2-range architecture)	±1.20000 A (1 A range) ±120.0000 µA (100 µA range)
Integration time	1 PLC (50 Hz: 20 ms; 60 Hz: 16.7 ms) × number of smoothing iterations (user-configured)	
Voltage output accuracy	±0.0150% of setting ±500 µV	
Voltage measurement accuracy	±0.0100% of reading ±100 µV	
Current measurement accuracy	1 A range	±0.0700% of reading ±100 µA
	100 µA range	±0.0350% of reading ±10 nA
Accuracy guarantee temperature and humidity range	23°C ±5°C, 80% RH (with warm-up time of at least 30 min.)	
Power supply	Universal (100 V to 240 V AC)	

Power supply frequency range	50 Hz / 60 Hz, ±2 Hz
Interfaces	LAN Communication: Setting by communication commands, acquisition of device status, acquisition of measurement values
Dimensions	430W × 132H × 483D mm (16.93" × 5.20" × 19.02")
Weight	10.3 kg (363.3oz.)
Accessories	User manual, power cord, rack frame, disk with computer application

Included computer application

	Item	Description
Control	Voltage generation	·ON / OFF / Save settings / Load settings
	Voltage/current measurement	·Current range switching ·Measured value logging (CSV file output)
	Sequence	·Edit CSV file / Load file ·Step execute / Continuous execute / Stop
Simulation	Graph display	·Waveform display of measured values ·Save screenshot (save image file)
	Charge/discharge simulation	·Configure linear interpolation method ·Configure curve-fitting method ·Perform charge/discharge simulation ·Automatically vary charge/discharge current values
	Transient response simulation based on equivalent circuit parameters	·Configure equivalent circuit parameters ·Perform transient response simulation

Operating environment: Windows 7 Service Pack 1 or later (except Windows 8)
Resolution: 1920 × 1080 (full HD) or better

Model



Model: BATTERY CELL VOLTAGE GENERATOR SS7081-50

Model No. (Order Code) : SS7081-50

Please contact your HIOKI distributor for a demonstration unit and further specifications.

Related Products



MEMORY HiCORDER MR8740T



DIGITAL VOLTMETER UNIT
U8991



VIR GENERATOR UNIT
U8794



FLYING PROBE TESTER
FA1240



IN-CIRCUIT TESTER FA1220



FA1220-02



FA1220-11

The combination of the MEMORY HiCORDER MR8740T and a dedicated unit can be used to build a temperature simulation test environment embedded in HILS.

In combination with the In-Circuit Tester series used for intermediate process inspection, mass production inspection of BMS boards is possible (final process yield improvement).

Note: Company names and product names appearing in this brochure are trademarks or registered trademarks of various companies.

HIOKI

HIOKI E. E. CORPORATION

DISTRIBUTED BY

HEADQUARTERS

81 Koizumi,
Ueda, Nagano 386-1192 Japan
<https://www.hioki.com/>



Scan for all regional contact information