

ZCN TYPE LIMIT SWITCH



■ Specification

Electrical capability	Insulation resistance	100 MΩ (at DC 500V)
	Dielectric strength	Between non-continuous terminal/AC 1,000V for 1 minute
		Between terminal and non-current carrying metal parts : AC 2,000V for 1 minute
Contact resistance	20 MΩ Max. (Initial), 100 MΩ Max. (Test)	
Operation speed		0.05mm ~ 0.5mm/s
Mechanical capability	Shock	Free position : 1,000mm/s ² Min. Operation limit : 300mm/s ² Min.
	Vibration	10~55Hz double amplitude 1.5mm
Life	Mechanical	1 million operations Min. (Switching frequency 60 times/minute)
	Electrical	0.5 million operations Min. (Switching frequency 20 times/minute)
Ambient condition	Temperature/humidity	-10~+80℃/25~95% RH
	Maximum switching frequency	Mechanical : 120 times/minute, Electrical : 20 times/minute
Weight		90g (ZCN - PR508)

MICRO /LIMIT SWITCH

18

■ Ratingsw

Voltage (V)	Non-Inductive load(A)		Inductive load(A)			
	Resistive load		Inductive load		Motor load	
	N.C.	N.O.	N.C.	N.O.	N.C.	N.O.
AC 125	15		10		3	1.5
AC 250	10		6		2	1
AC 600	3		2		1.5	0.75
DC 8	15		10		-	-
DC 14	15		10		-	-
DC 30	6		5		-	-
DC 125	0.4		0.05		-	-
DC 250	0.2		0.03		-	-

■ Diagram

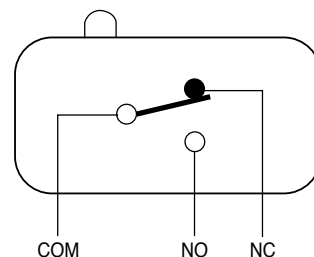

MICRO /LIMIT SWITCH

ZCN TYPE LIMIT SWITCH



HANYOUNG

Construction

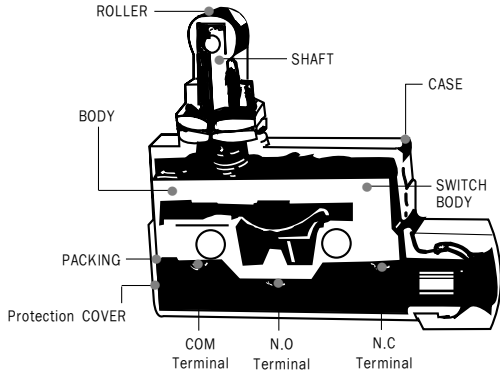

Electrical life cycle

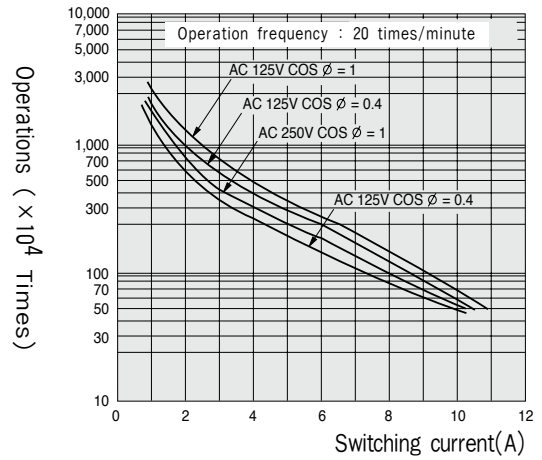

Dimension

Long button
ZCN-P5010

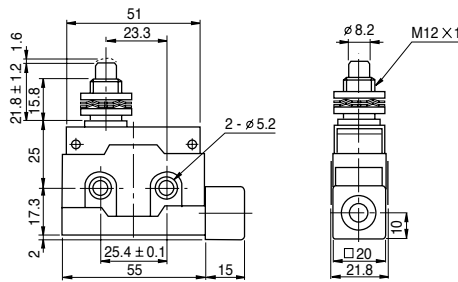

OF Max.	600g
RF Min.	100g
PT Max.	1.6mm
OT Min.	5mm
MD Max.	0.2mm
OP	21.8mm

Short roller lever
ZCN-R504A

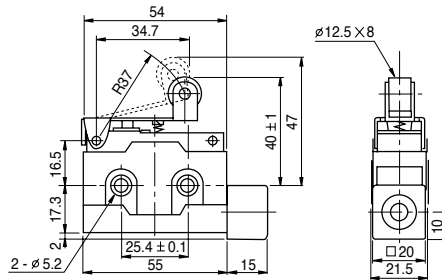

OF Max.	600g
RF Min.	80g
OT Min.	2mm
MD Max.	1.5mm
OP	40mm
FP Max.	47mm

Long roller lever
ZCN-R504C

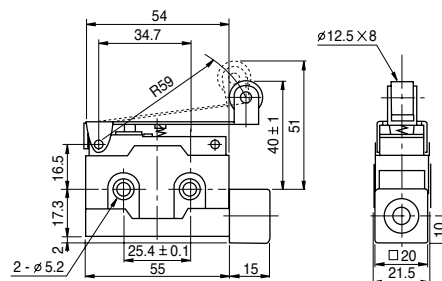

OF Max.	280g
RF Min.	60g
OT Min.	5mm
MD Max.	3mm
OP	40mm
FP Max.	51mm

MICRO /LIMIT SWITCH

ZCN TYPE LIMIT SWITCH



Short lever
ZCN-L507A

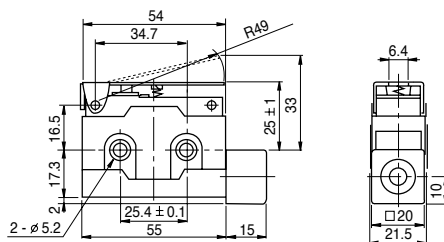
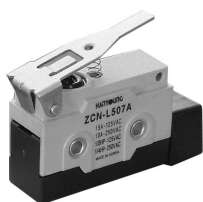

OF Max.	400g
RF Min.	80g
OT Min.	2.5mm
MD Max.	1mm
OP	25mm
FP Max.	33mm

Long lever
ZCN-L507C

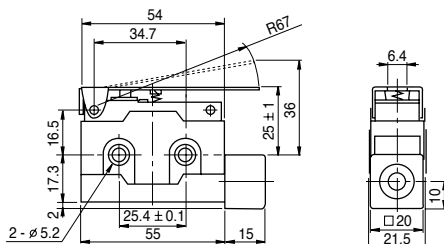

OF Max.	280g
RF Min.	60g
OT Min.	4mm
MD Max.	1.4mm
OP	25mm
FP Max.	36mm

Roller push button(Horizontal)
ZCN-PR508V

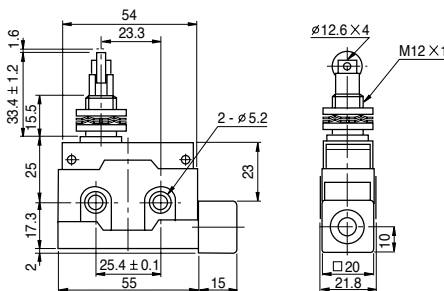

OF Max.	600g
RF Min.	100g
PT Max.	1.6mm
OT Min.	5mm
MD Max.	0.2mm
OP	33.4mm

Roller push button(Vertical)
ZCN-PR508H

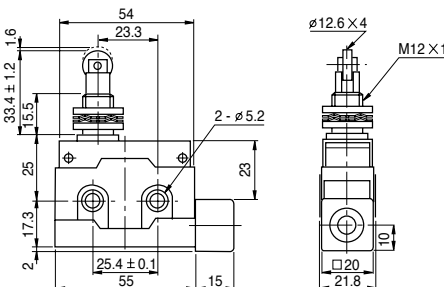

OF Max.	600g
RF Min.	100g
PT Max.	1.6mm
OT Min.	5mm
MD Max.	0.2mm
OP	33.4mm