

HIOKI

CURRENT SENSOR Series
CURRENT PROBE Series

NEW



**Application-optimized
Current Sensors and Current Probes**

CE 

Application-optimized current sensors and current probes

Hioki offers lineup of current sensors and current probes to accommodate current measurement requirements in a variety of applications, from development and evaluation in advanced fields to quality control of commercial power supplies.



Evaluating power conversion efficiency in EVs

Evaluate vehicles' overall power conversion efficiency in order to develop automobiles that run further with less energy.

CT6904A, CT687xA series + PW8001



Evaluating the fuel (energy) efficiency of finished vehicles

Measure fuel efficiency based on the international standard (WLTP) in order to evaluate the fuel efficiency of finished vehicles.

CT684xA series + PW3390



Evaluating power devices in power supply circuits

Observe the inputs and outputs of the current waveform in order to evaluate whether power devices are providing the required level of performance.

CT67xx series, 327x series + MR6000



Evaluating systems used to control accessory components in automobiles

Observe current waveforms of various magnitudes that fluctuate depending on the state of the device in question, including dark current, inrush current, and drive current, in order to evaluate accessory control.

CT67xx series, 327x series + MR6000



Maintaining power quality

Continuously monitor power quality and analyze the causes of power supply issues in order to maintain stable power quality.

CT7xxx series, CT9667-0x series + PQ3198, PQ3100



Assessing the power consumption of equipment and systems

Assess the power consumption of devices and systems in order to pursue energy-saving activities and achieve the goals of the UN's Sustainable Development Goals (SDGs).

CT7xxx series, CT9667-0x series + PW3365

Applications by operating current and operating frequency

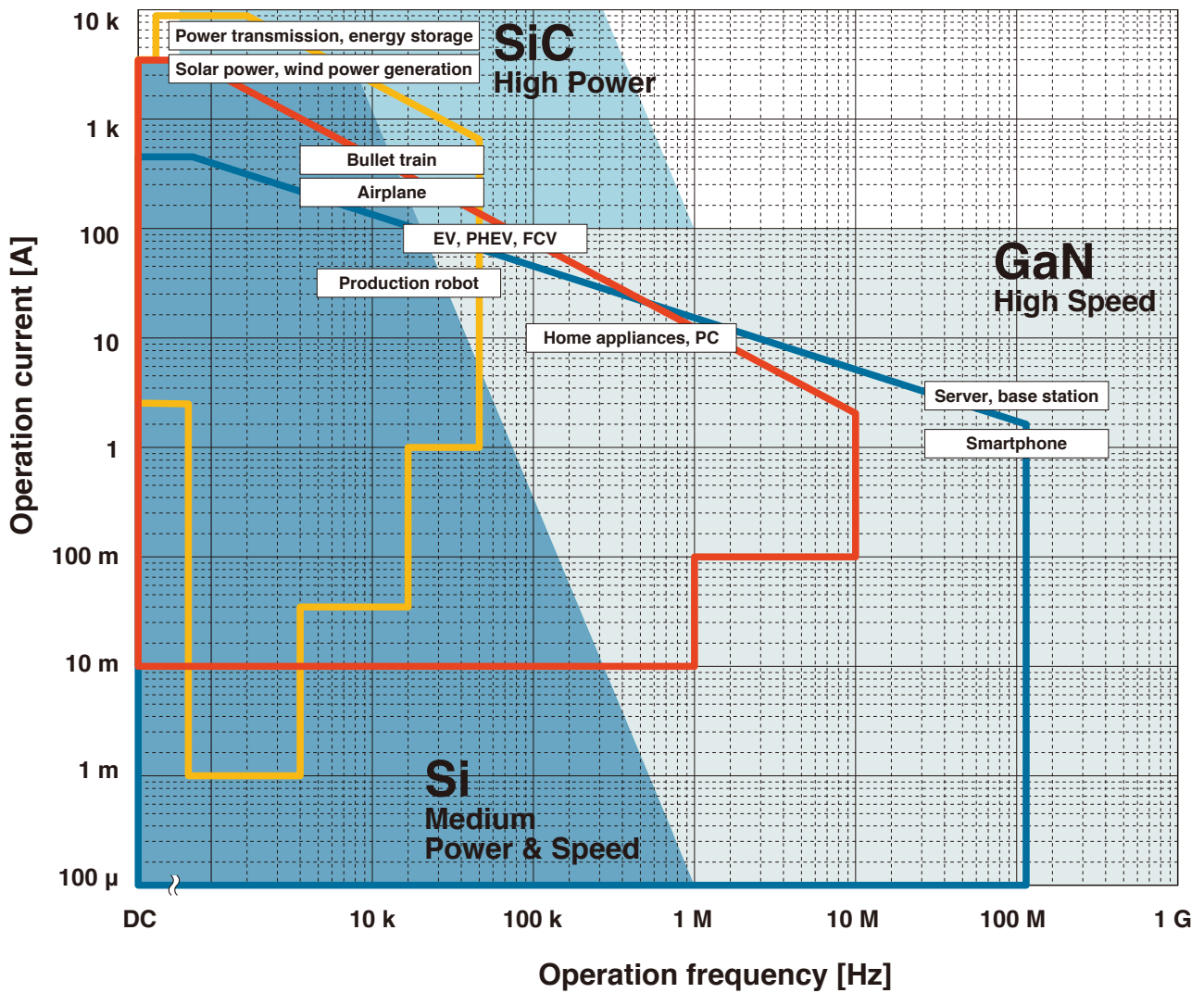

High-accuracy measurement		pass-through types	- EV inverter systems R&D - Assessment of reactor and transformer losses
		clamp types	- WLTP-compliant fuel economy (electricity cost) performance testing
Waveform observation		High-sensitivity observation	- Evaluation of automotive accessory control - Evaluation of power components in power supply circuits
		Observation of minuscule currents	- Evaluation of automotive accessory control - Development and evaluation of power-saving devices such as wearables
		Observation of large currents	- Fluctuations in fluctuation of load currents of large industrial equipment - Measurement of inrush currents flowing when starting an engine
Grid power quality control		Measurement of load currents	- Assessment of power consumption - Periodic inspection of power supply equipment and monitoring of power quality
		Measurement of large currents	
		Measurement of leakage currents	- Detection of intermittent electrical leaks - Search for the locations of electrical leaks

Current Sensors Current Probes Lineup

Hioki's first current sensor was a magnetic current sensor developed in-house in 1971. We've pursued sensing technologies over the past 50 years, providing a variety of current sensors for the full range of measurement applications.

High-accuracy measurement

These models, rated for 20 A to 2000 A, measure currents in a frequency band from DC to 10 MHz with a high degree of accuracy. They're used in applications that require high measurement accuracy, for example evaluation of inverter equipment and evaluation of loss in reactors and transformers.

Pass-through types

Pass-through sensors deliver the ultimate level of accuracy and stability. With a broadband measurement at up to 10 MHz and measurement of large currents of up to 2000 A, they're used in state-of-the-art research and development.



EV inverter system R&D

Evaluation of reactor and transformer losses

Clamp types

Clamp-type sensors are quick and easy to connect, and used for testing finished products, an application where it is difficult to cut wires. Capable of functioning at temperatures from -40°C to 85°C, they're used in high-temperature environments such as engine compartments.



WLTP-compliant fuel economy

(electricity cost) performance testing

Direct-wired types

Directly wired current sensors deliver world-class accuracy and frequency band characteristics (50 A model) by Hioki's proprietary DCCT (Direct Connection Current Transducer) method



Evaluation of reactor and transformer losses

Evaluation of inverters in energy-saving household appliances

Waveform observation

These models, rated from 0.5 A to 500 A, measure current waveforms in a frequency band of DC to 120 MHz. They're used to analyze fluctuations during operation of various types of equipment operation, including standby current, inrush current, load current, and control current.

Grid power quality control

These models are engineered primarily to measure current at commercial frequencies (50/60 Hz). They're used in applications such as power quality checks and power consumption assessments. We offer models with specifications suitable for a range of measurement locations, from leakage currents to large currents.

High-sensitivity observation

These models can measure current waveforms that range in magnitude from minuscule to large. With the high-sensitivity ranges and an output rate of 10 V/A, minuscule currents that fluctuate at high speeds can be clearly observed.

Measurement of load current

These sensors are primarily designed to measure commercial power supplies. They're used to monitor and analyze power quality and to measure power consumption.



Evaluation of automotive accessory control

Evaluation of power devices in power supply circuits

Assessment of power consumption

Periodic inspection of power supply equipment and monitoring of power quality

Observation of minuscule currents

These models can measure minuscule current waveforms, including control currents flowing in control circuits and fluctuations in the current consumption of compact electronic devices that operate at small currents.

Measurement of large currents

These sensors can measure large currents of up to 6000 A. Their slim, flexible form make them easy to insert into narrow gaps and between wires.



Evaluation of automotive accessory control

Development and evaluation of power-saving devices such as wearables

Assessment of power consumption

Periodic inspection of power supply equipment and monitoring of power quality

Observation of large currents

These models can measure large current waveforms, including fluctuations in load current from the operation of industrial equipment and inrush currents when power supplies are activated.

Measurement of leakage currents

These sensors are used to measure minuscule currents such as leakage currents.

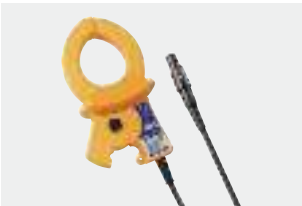

Fluctuations of load currents of large industrial equipment

Measurement of inrush currents flowing at engine start

Detection of intermittent electrical leaks

Search for the locations of electrical leaks

High-accuracy measurement Output terminals: ME15W

Pass-through types

50 A	$\phi 24$ mm (0.94 in.)	$\phi 24$ mm (0.94 in.) NEW		
	50 A	50 A		
	DC to 1 MHz	DC to 10 MHz		
	CT6862-05	CT6872, CT6872-01		
200 A	$\phi 24$ mm (0.94 in.)	$\phi 24$ mm (0.94 in.) NEW		
	200 A	200 A		
	DC to 500 kHz	DC to 10 MHz		
	CT6863-05	CT6873, CT6873-01		
500 A	$\phi 36$ mm (1.42 in.)	$\phi 36$ mm (1.42 in.)	$\phi 32$ mm (1.26 in.)	$\phi 32$ mm (1.26 in.)
	500 A	500 A	500 A	500 A
	DC to 2 MHz	DC to 1.5 MHz	DC to 4 MHz	DC to 2 MHz
	CT6875A	CT6875A-1	CT6904A	CT6904A-1
800 A	$\phi 32$ mm (1.26 in.)	$\phi 32$ mm (1.26 in.)		
	800 A	800 A		
	DC to 4 MHz	DC to 2 MHz		
	CT6904A-2	CT6904A-3		
1000 A 2000 A	$\phi 36$ mm (1.42 in.)	$\phi 36$ mm (1.42 in.)	$\phi 80$ mm (3.15 in.)	
	1000 A	1000 A	2000 A	
	DC to 1.5 MHz	DC to 1.2 MHz	DC to 1 MHz	
	CT6876A	CT6876A-1	CT6877A, CT6877A-1	

Clamp types

20 A 200 A	$\phi 20$ mm (0.79 in.)	$\phi 20$ mm (0.79 in.)	$\phi 46$ mm (1.81 in.)
	20 A	200 A	20 A/200 A
	DC to 2 MHz	DC to 700 kHz	1 Hz to 100 kHz
	CT6841A	CT6843A	9272-05
500 A 1000 A	$\phi 20$ mm (0.79 in.)	$\phi 50$ mm (1.97 in.)	$\phi 50$ mm (1.97 in.)
	500 A	500 A	1000 A
	DC to 500 kHz	DC to 200 kHz	DC to 100 kHz
	CT6844A	CT6845A	CT6846A

Waveform observation Output terminals: BNC

Minuscule current waveforms can be observed more clearly by generating output at 10 V/A

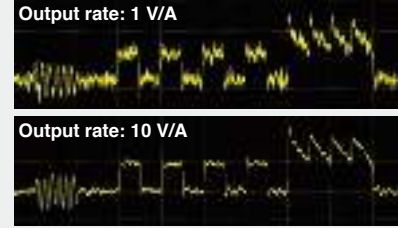

Model	Measurement range	Output rate
CT6710 CT6711	0.5 A	10 V/A
	5 A	1 V/A
	30 A	0.1 V/A
CT6700 CT6701	5 A	1 V/A
3273-50 3276	30 A	0.1 V/A
3274	150 A	0.01 V/A
3275	500 A	0.01 V/A

High-sensitivity observation

0.5 A 5 A 30 A	$\phi 5$ mm (0.20 in.)	$\phi 5$ mm (0.20 in.)
	0.5 A, 5 A, 30 A	0.5 A, 5 A, 30 A
	DC to 50 MHz	DC to 120 MHz
	CT6710	CT6711

Observation of minuscule currents









5 A	$\phi 5$ mm (0.20 in.)	$\phi 5$ mm (0.20 in.)
	5 A	5 A
	DC to 50 MHz	DC to 120 MHz
	CT6700	CT6701

Observation of large currents



30 A	$\phi 5$ mm (0.20 in.)	$\phi 5$ mm (0.20 in.)
	30 A	30 A
	DC to 50 MHz	DC to 100 MHz
	3273-50	3276
150 A 500 A	$\phi 20$ mm (0.79 in.)	$\phi 20$ mm (0.79 in.)
	150 A	500 A
	DC to 10 MHz	DC to 2 MHz
	3274	3275

Grid power quality control Output terminals: **PL14**

Measurement of load current

60 A 100 A	 ϕ15 mm (0.59 in.) 60 A 40 Hz to 20 kHz CT7126	 ϕ15 mm (0.59 in.) 100 A 40 Hz to 20 kHz CT7131	
	100 A	 ϕ33 mm (1.30 in.) 100 A DC to 5 kHz CT7731	 ϕ33 mm (1.30 in.) 100 A DC to 10 kHz CT7631
600 A		 ϕ33 mm (1.30 in.) 600 A DC to 5 kHz CT7736	 ϕ33 mm (1.30 in.) 600 A DC to 10 kHz CT7636
	2000 A	 ϕ55 mm (2.17 in.) 2000 A DC to 5 kHz CT7742	 ϕ55 mm (2.17 in.) 2000 A DC to 10 kHz CT7642

Measurement of large currents









6000 A	 ϕ100 mm (3.94 in.) 6000 A 10 Hz to 50 kHz CT7044	 ϕ180 mm (7.09 in.) 6000 A 10 Hz to 50 kHz CT7045	 ϕ254 mm (10.0 in.) 6000 A 10 Hz to 50 kHz CT7046
--------	---	---	---

Measurement of leakage current

6 A	 ϕ40 mm (1.57 in.) 6 A 40 Hz to 5 kHz CT7116
-----	--



Grid power quality control Output terminals: **BNC***

Measurement of load current

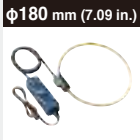

5 A 50 A	 ϕ15 mm (0.59 in.) 5 A 40 Hz to 5 kHz 9694	 ϕ15 mm (0.59 in.) 50 A 40 Hz to 5 kHz 9695-02**1	
	100 A	 ϕ15 mm (0.59 in.) 100 A 40 Hz to 5 kHz 9660	 ϕ15 mm (0.59 in.) 100 A 40 Hz to 5 kHz 9695-03**1
500 A 1000 A		 ϕ46 mm (1.81 in.) 10 A to 500 A**2 40 Hz to 1 kHz CT6500	 ϕ46 mm (1.81 in.) 10 A to 500 A**2 40 Hz to 3 kHz 9661
		 ϕ46 mm (1.81 in.) 500 A 40 Hz to 1 kHz CT6500	 ϕ46 mm (1.81 in.) 500 A 40 Hz to 5 kHz 9661

*1: The 9695-02 and 9695-03 use an M3 terminal block for their output terminals. Optional Connection Cable 9219 is required.
*2: Range-switched (10, 20, 50, 100, 200, 500 A AC)
*3: Range-switched (20, 50, 100, 200, 500, 1000 A AC)

Measurement of large currents

500 A 5000 A	 ϕ100 mm (3.94 in.) 500 A, 5000 A 10 Hz to 20 kHz CT9667-01	 ϕ180 mm (7.09 in.) 500 A, 5000 A 10 Hz to 20 kHz CT9667-02	 ϕ254 mm (10.0 in.) 500 A, 5000 A 10 Hz to 20 kHz CT9667-03
-----------------	--	---	---

















Measurement of leakage current

10 A	 ϕ40 mm (1.57 in.) 10 A 40 Hz to 5 kHz 9657-10	 ϕ30 mm (1.18 in.) 10 A 40 Hz to 5 kHz 9675
------	---	---







High-accuracy measurement

Output terminals: ME15W



Pass-through types

Model	Appearance	Rated primary current	Maximum peak current	Withstand voltage*2	Output voltage	Frequency range	Linearity error	Offset error	Amplitude errors
CT6862-05		50 Arms	±141 A peak	7.4 kV AC	40 mV/A	DC to 1 MHz	-	-	-
CT6872		50 Arms	±200 A peak	7.4 kV AC	40 mV/A	DC to 10 MHz	±2 ppm	±5 ppm	DC: 7 ppm 10 Hz to 100 Hz: 0.005% 100 Hz to 1 kHz: 0.01% 1 kHz to 50 kHz: 0.1% 50 kHz to 100 kHz: 0.3% 100 kHz to 300 kHz: 1% 300 kHz to 1 MHz: 3%
CT6872-01		50 Arms	±200 A peak	7.4 kV AC	40 mV/A	DC to 10 MHz	±2 ppm	±5 ppm	
CT6863-05		200 Arms	±565 A peak	7.4 kV AC	10 mV/A	DC to 500 kHz	-	-	-
CT6873		200 Arms	±350 A peak*1	7.4 kV AC	10 mV/A	DC to 10 MHz	±2 ppm	±5 ppm	DC: ±7 ppm 10 Hz to 500 Hz: ±0.005% 500 Hz to 3 kHz: ±0.01% 3 kHz to 30 kHz: ±0.1% 30 kHz to 100 kHz: ±0.4% 100 kHz to 400 kHz: ±1% 400 kHz to 1 MHz: ±3%
CT6873-01		200 Arms	±350 A peak*1	7.4 kV AC	10 mV/A	DC to 10 MHz	±2 ppm	±5 ppm	
CT6875A		500 Arms	±1500 A peak*1	7.4 kV AC	4 mV/A	DC to 2 MHz	±5 ppm	±5 ppm	DC: ±10 ppm 10 Hz to 100 Hz: ±0.005% 100 Hz to 1 kHz: ±0.02% 1 kHz to 20 kHz: ±0.08% 20 kHz to 100 kHz: ±0.5% 100 kHz to 300 kHz: ±1% 300 kHz to 1 MHz: ±5%
CT6875A-1		500 Arms	±1500 A peak*1	7.4 kV AC	4 mV/A	DC to 1.5 MHz	±5 ppm	±5 ppm	
CT6904A		500 Arms	±1000 A peak*1	7.4 kV AC	4 mV/A	DC to 4 MHz	±5 ppm	±10 ppm	-
CT6904A-1		500 Arms	±1000 A peak*1	7.4 kV AC	4 mV/A	DC to 2 MHz	±5 ppm	±10 ppm	-
CT6904A-2		800 Arms	±1200 A peak*1	7.4 kV AC	2 mV/A	DC to 4 MHz	±12.5 ppm	±10 ppm	-
CT6904A-3		800 Arms	±1200 A peak*1	7.4 kV AC	2 mV/A	DC to 2 MHz	±12.5 ppm	±10 ppm	-
CT6876A		1000 Arms	±1800 A peak*1	7.4 kV AC	2 mV/A	DC to 1.5 MHz	±5 ppm	±5 ppm	DC: ±10 ppm 10 Hz to 100 Hz: ±0.005% 100 Hz to 1 kHz: ±0.03% 1 kHz to 10 kHz: ±0.2% 10 kHz to 100 kHz: ±1% 100 kHz to 300 kHz: ±3% 300 kHz to 1 MHz: ±15%
CT6876A-1		1000 Arms	±1800 A peak*1	7.4 kV AC	2 mV/A	DC to 1.2 MHz	±5 ppm	±5 ppm	
CT6877A		2000 Arms	±3200 A peak*1	7.4 kV AC	1 mV/A	DC to 1 MHz	±10 ppm	±5 ppm	DC: ±15 ppm 10 Hz to 100 Hz: ±0.01% 100 Hz to 1 kHz: ±0.04% 1 kHz to 10 kHz: ±0.25% 10 kHz to 100 kHz: ±1% 100 kHz to 300 kHz: ±2% 300 kHz to 700 kHz: ±10%
CT6877A-1		2000 Arms	±3200 A peak*1	7.4 kV AC	1 mV/A	DC to 1 MHz	±10 ppm	±5 ppm	

Clamp types

9272-05		20 Arms, 200 Arms	±71 A peak, ±430 A peak	5.4 kV AC	100 mV/A, 10 mV/A	1 Hz to 100 kHz	-	-	-
CT6841A		20 Arms	±60 A peak*1	4.26 kV AC	100 mV/A	DC to 2 MHz	±20 ppm	-	-
CT6843A		200 Arms	±600 A peak*1	4.26 kV AC	10 mV/A	DC to 700 kHz	±20 ppm	-	-
CT6844A		500 Arms	±800 A peak*1	4.26 kV AC	4 mV/A	DC to 500 kHz	±20 ppm	-	-
CT6845A		500 Arms	±1500 A peak*1	4.26 kV AC	4 mV/A	DC to 200 kHz	±20 ppm	-	-
CT6846A		1000 Arms	±1900 A peak*1	4.26 kV AC	2 mV/A	DC to 100 kHz	±20 ppm	-	-

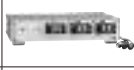
Direct-wired types

PW9100A-3		50 Arms	±200 A peak*1	5.4 kV AC	40 mV/A	DC to 3.5 MHz	-	-	-
PW9100A-4		50 Arms	±200 A peak*1	5.4 kV AC	40 mV/A	DC to 3.5 MHz	-	-	-







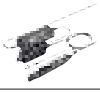

*1: Within 20 ms and 40°C (104°F) or less *2: Sensed current of 1 mA, 50/60 Hz, 1 min

High-accuracy measurement							Output terminals: ME15W		
pass-through types									
Model	Amplitude accuracy		Phase Shift Values	Delay times	Diameter of measurable conductors	Cable length	Operating temperature	Maximum rated voltage to earth	Automatic phase correction*3
	DC	50/60 Hz							
CT6862-05	±0.05% rdg. ±0.01% f.s.	±0.05% rdg. ±0.01% f.s.	300 kHz, -10.96°	101 ns	φ24 mm (0.94 in.)	3 m (9.84 ft.)	-30°C to 85°C -22°F to 185°F	1000 V CAT III	-
CT6872	±0.03% rdg. ±0.002% f.s.	±0.03% rdg. ±0.007% f.s.	100 kHz, -1.28°	46 ns	φ24 mm (0.94 in.)	3 m (9.84 ft.)	-40°C to 85°C -40°F to 185°F	1000 V CAT III	Yes
CT6872-01	±0.03% rdg. ±0.002% f.s.	±0.03% rdg. ±0.007% f.s.	100 kHz, -2.63°	82 ns	φ24 mm (0.94 in.)	10 m (32.81 ft.)	-40°C to 85°C -40°F to 185°F	1000 V CAT III	Yes
CT6863-05	±0.05% rdg. ±0.01% f.s.	±0.05% rdg. ±0.01% f.s.	100 kHz, -4.60°	128 ns	φ24 mm (0.94 in.)	3 m (9.84 ft.)	-30°C to 85°C -22°F to 185°F	1000 V CAT III	-
CT6873	±0.03% rdg. ±0.002% f.s.	±0.03% rdg. ±0.007% f.s.	100 kHz, -0.75°	36 ns	φ24 mm (0.94 in.)	3 m (9.84 ft.)	-40°C to 85°C -40°F to 185°F	1000 V CAT III	Yes
CT6873-01	±0.03% rdg. ±0.002% f.s.	±0.03% rdg. ±0.007% f.s.	100 kHz, -2.10°	69 ns	φ24 mm (0.94 in.)	10 m (32.81 ft.)	-40°C to 85°C -40°F to 185°F	1000 V CAT III	Yes
CT6875A	0.04% rdg. ±0.008% f.s.	0.04% rdg. ±0.008% f.s.	200 kHz, -10.45°	145 ns	φ36 mm (1.42 in.)	3 m (9.84 ft.)	-40°C to 85°C -40°F to 185°F	1000 V CAT III	Yes
CT6875A-1	0.04% rdg. ±0.008% f.s.	0.04% rdg. ±0.008% f.s.	200 kHz, 12.87°	179 ns	φ36 mm (1.42 in.)	10 m (32.81 ft.)	-40°C to 85°C -40°F to 185°F	1000 V CAT III	Yes
CT6904A	±0.025% rdg. ±0.007% f.s.	±0.02% rdg. ±0.007% f.s.	300 kHz, -9.82°	91 ns	φ32 mm (1.26 in.)	3 m (9.84 ft.)	-10°C to 50°C 14°F to 122°F	1000 V CAT III	Yes
CT6904A-1	±0.025% rdg. ±0.007% f.s.	±0.02% rdg. ±0.007% f.s.	300 kHz, -9.82°	91 ns	φ32 mm (1.26 in.)	10 m (32.81 ft.)	-10°C to 50°C 14°F to 122°F	1000 V CAT III	Yes
CT6904A-2	±0.030% rdg. ±0.009% f.s.	±0.025% rdg. ±0.009% f.s.	300 kHz, -9.82°	91 ns	φ32 mm (1.26 in.)	3 m (9.84 ft.)	-10°C to 50°C 14°F to 122°F	1000 V CAT III	Yes
CT6904A-3	±0.030% rdg. ±0.009% f.s.	±0.025% rdg. ±0.009% f.s.	300 kHz, -9.82°	91 ns	φ32 mm (1.26 in.)	10 m (32.81 ft.)	-10°C to 50°C 14°F to 122°F	1000 V CAT III	Yes
CT6876A	0.04% rdg. ±0.008% f.s.	0.04% rdg. ±0.008% f.s.	200 kHz, -12.96°	180 ns	φ36 mm (1.42 in.)	3 m (9.84 ft.)	-40°C to 85°C -40°F to 185°F	1000 V CAT III	Yes
CT6876A-1	0.04% rdg. ±0.008% f.s.	0.04% rdg. ±0.008% f.s.	200 kHz, -14.34°	199 ns	φ36 mm (1.42 in.)	10 m (32.81 ft.)	-40°C to 85°C -40°F to 185°F	1000 V CAT III	Yes
CT6877A	0.04% rdg. ±0.008% f.s.	0.04% rdg. ±0.008% f.s.	100 kHz, -2.63°	73 ns	φ80 mm (3.15 in.)	3 m (9.84 ft.)	-40°C to 85°C -40°F to 185°F	1000 V CAT III	Yes
CT6877A-1	0.04% rdg. ±0.008% f.s.	0.04% rdg. ±0.008% f.s.	100 kHz -3.34°	93 ns	φ80 mm (3.15 in.)	10 m (32.81 ft.)	-40°C to 85°C -40°F to 185°F	1000 V CAT III	Yes
clamp types									
9272-05	-	±0.3% rdg. ±0.01% f.s.	50 kHz, -3.34° 50 kHz, -4.18°	186 ns, 232 ns	φ46 mm (1.81 in.)	3 m (9.84 ft.)	0°C to 50°C 32°F to 122°F	600 V CAT III	-
CT6841A	±0.2% rdg. ±0.05% f.s.	±0.2% rdg. ±0.01% f.s.	100 kHz, -3.59°	100 ns	φ20 mm (0.79 in.)	3 m (9.84 ft.)	-40°C to 85°C -40°F to 185°F	-	Yes
CT6843A	±0.2% rdg. ±0.02% f.s.	±0.2% rdg. ±0.01% f.s.	100 kHz, -3.96°	110 ns	φ20 mm (0.79 in.)	3 m (9.84 ft.)	-40°C to 85°C -40°F to 185°F	-	Yes
CT6844A	±0.2% rdg. ±0.02% f.s.	±0.2% rdg. ±0.01% f.s.	100 kHz, -3.92°	109 ns	φ20 mm (0.79 in.)	3 m (9.84 ft.)	-40°C to 85°C -40°F to 185°F	-	Yes
CT6845A	±0.2% rdg. ±0.02% f.s.	±0.2% rdg. ±0.01% f.s.	10 kHz, -0.94°	261 ns	φ50 mm (1.97 in.)	3 m (9.84 ft.)	-40°C to 85°C -40°F to 185°F	-	Yes
CT6846A	±0.2% rdg. ±0.02% f.s.	±0.2% rdg. ±0.01% f.s.	10 kHz, -1.05°	292 ns	φ50 mm (1.97 in.)	3 m (9.84 ft.)	-40°C to 85°C -40°F to 185°F	-	Yes
direct-wired types									
PW9100A-3	±0.02% rdg. ±0.007% f.s.	±0.02% rdg. ±0.005% f.s.	300 kHz, -2.80°	26 ns	M6 screw terminals	3 ch	0°C to 40°C 32°F to 104°F	1000 V CAT II 600 V CAT III	Yes
PW9100A-4	±0.02% rdg. ±0.007% f.s.	±0.02% rdg. ±0.005% f.s.	300 kHz, -2.80°	26 ns	M6 screw terminals	4 ch	0°C to 40°C 32°F to 104°F	1000 V CAT II 600 V CAT III	Yes

*3: When using PW8001

Waveform observation









Output terminals: BNC





Model	Appearance	Rated current: output rate	Frequency range	Rise time (10% to 90%)	Delay time	Amplitude accuracy	Diameter of measurable conductors	Cable length*1	Operating temperature
High-sensitivity observation of currents ranging in magnitude from minuscule to large									
CT6710		0.5 Arms: 10 V/A 5 Arms: 1 V/A 30 Arms: 0.1 V/A	DC to 50 MHz	7.0 ns or less	12 ns*2	±3.0% rdg. ±1 mV	φ5 mm (0.20 in.)	1.5 m, 1 m (4.92 ft., 3.28 ft.)	0°C to 40°C 32°F to 104°F
CT6711		0.5 Arms: 10 V/A 5 Arms: 1 V/A 30 Arms: 0.1 V/A	DC to 120 MHz	2.9 ns or less	12 ns*2	±3.0% rdg. ±1 mV	φ5 mm (0.20 in.)	1.5 m, 1 m (4.92 ft., 3.28 ft.)	0°C to 40°C 32°F to 104°F
Observation of minuscule currents									
CT6700		5 Arms: 1 V/A	DC to 50 MHz	7.0 ns or less	13 ns	±3.0% rdg. ±1 mV	φ5 mm (0.20 in.)	1.5 m, 1 m (4.92 ft., 3.28 ft.)	0°C to 40°C 32°F to 104°F
CT6701		5 Arms: 1 V/A	DC to 120 MHz	2.9 ns or less	12 ns	±3.0% rdg. ±1 mV	φ5 mm (0.20 in.)	1.5 m, 1 m (4.92 ft., 3.28 ft.)	0°C to 40°C 32°F to 104°F
Observation of large currents									
3273-50		30 Arms: 0.1 V/A	DC to 50 MHz	7.0 ns or less	16 ns	±1.0% rdg. ±1 mV	φ5 mm (0.20 in.)	1.5 m, 1 m (4.92 ft., 3.28 ft.)	0°C to 40°C 32°F to 104°F
3276		30 Arms: 0.1 V/A	DC to 100 MHz	3.5 ns or less	14 ns	±1.0% rdg. ±1 mV	φ5 mm (0.20 in.)	1.5 m, 1 m (4.92 ft., 3.28 ft.)	0°C to 40°C 32°F to 104°F
3274		150 Arms: 0.01 V/A	DC to 10 MHz	35 ns or less	40 ns	±1.0% rdg. ±1 mV	φ20 mm (0.79 in.)	2.0 m, 1 m (6.56 ft., 3.28 ft.)	0°C to 40°C 32°F to 104°F
3275		500 Arms: 0.01 V/A	DC to 2 MHz	175 ns or less	66 ns	±1.0% rdg. ±5 mV	φ20 mm (0.79 in.)	2.0 m, 1 m (6.56 ft., 3.28 ft.)	0°C to 40°C 32°F to 104°F

*1: Sensor cable: cable between relay box and sensor for models with relay boxes (i.e. CT6710, CT6711), power supply cable for other models *2: When using 0.5 A range: 13 ns















Grid power quality control

Output terminals: PL14

Model	Appearance	Rated current	Frequency range	Amplitude accuracy	Diameter of measurable conductors	Cable length	Operating temperature	CAT
Measurement of load current								
CT7126		60 A AC	40 Hz to 20 kHz	±0.3% rdg. ±0.01% f.s.	φ15 mm (0.59 in.)	2.5 m (8.20 ft.)	-10°C to 50°C 14°F to 122°F	300 V CAT III
CT7131		100 A AC	40 Hz to 20 kHz	±0.3% rdg. ±0.02% f.s.	φ15 mm (0.59 in.)	2.5 m (8.20 ft.)	-10°C to 50°C 14°F to 122°F	300 V CAT III
CT7731		100 A AC/DC	DC to 5 kHz	±1.0% rdg. ±0.5% f.s.	φ33 mm (1.30 in.)	2.5 m (8.20 ft.)	-25°C to 65°C -13°F to 149°F	600 V CAT IV
CT7631		100 A AC/DC	DC to 10 kHz	±1.0% rdg. ±0.5% f.s.	φ33 mm (1.30 in.)	2.5 m (8.20 ft.)	-25°C to 65°C -13°F to 149°F	600 V CAT IV
CT7736		600 A AC/DC	DC to 5 kHz	±2.0% rdg. ±0.5% f.s.	φ33 mm (1.30 in.)	2.5 m (8.20 ft.)	-25°C to 65°C -13°F to 149°F	600 V CAT IV
CT7636		600 A AC/DC	DC to 10 kHz	±2.0% rdg. ±0.5% f.s.	φ33 mm (1.30 in.)	2.5 m (8.20 ft.)	-25°C to 65°C -13°F to 149°F	600 V CAT IV 1000 V CAT III
CT7136		600 A AC	40 Hz to 20 kHz	±0.3% rdg. ±0.01% f.s.	φ46 mm (1.81 in.)	2.5 m (8.20 ft.)	-10°C to 50°C 14°F to 122°F	600 V CAT IV 1000 V CAT III
CT7742		2000 A AC/DC	DC to 5 kHz	±1.5% rdg. ±0.5% f.s.	φ55 mm (2.17 in.)	2.5 m (8.20 ft.)	-25°C to 65°C -13°F to 149°F	600 V CAT IV 1000 V CAT III
CT7642		2000 A AC/DC	DC to 10 kHz	±1.5% rdg. ±0.5% f.s.	φ55 mm (2.17 in.)	2.5 m (8.20 ft.)	-25°C to 65°C -13°F to 149°F	600 V CAT IV 1000 V CAT III

Model	Appearance	Rated current	Frequency range	Amplitude accuracy	Diameter of measurable conductors	Cable length	Operating temperature	CAT
Measurement of large currents								
CT7044		6000 A AC	10 Hz to 50 kHz	±1.5% rdg. ±0.25% f.s.	φ100 mm (3.94 in.)	2.3 m, 0.2 m* (7.55 ft., 0.66 ft.)	-25°C to 65°C -13°F to 149°F	600 V CAT IV 1000 V CAT III
CT7045		6000 A AC	10 Hz to 50 kHz	±1.5% rdg. ±0.25% f.s.	φ180 mm (7.09 in.)	2.3 m, 0.2 m* (7.55 ft., 0.66 ft.)	-25°C to 65°C -13°F to 149°F	600 V CAT IV 1000 V CAT III
CT7046		6000 A AC	10 Hz to 50 kHz	±1.5% rdg. ±0.25% f.s.	φ254 mm (10.00 in.)	2.3 m, 0.2 m* (7.55 ft., 0.66 ft.)	-25°C to 65°C -13°F to 149°F	600 V CAT IV 1000 V CAT III
Measurement of leakage current								
CT7116		6 A AC	40 Hz to 5 kHz	±1.0% rdg. ±0.05% f.s.	φ40 mm (1.57 in.)	2.5 m (8.20 ft.)	-25°C to 65°C -13°F to 149°F	-

*Sensor cable: between flexible loop and circuit box for flexible sensors (e.g. CT7044), output cable for CT7116











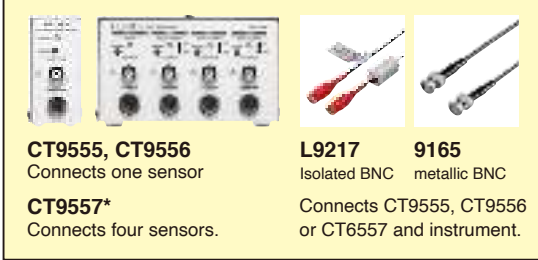









Grid power quality control								Output terminals: BNC
Model	Appearance	Rated current	Frequency range	Amplitude accuracy	Diameter of measurable conductors	Cable length	Operating temperature	CAT
Measurement of load current								
9694		5 A AC	40 Hz to 5 kHz	±0.3% rdg. ±0.02% f.s.	φ15 mm (0.59 in.)	3 m (9.84 ft.)	0°C to 50°C 32°F to 122°F	300 V CAT III
9695-02*1		50 A AC	40 Hz to 5 kHz	±0.3% rdg. ±0.02% f.s.	φ15 mm (0.59 in.)	-	0°C to 50°C 32°F to 122°F	300 V CAT III
9660		100 A AC	40 Hz to 5 kHz	±0.3% rdg. ±0.02% f.s.	φ15 mm (0.59 in.)	3 m (9.84 ft.)	0°C to 50°C 32°F to 122°F	300 V CAT III
9695-03*1		100 A AC	40 Hz to 5 kHz	±0.3% rdg. ±0.02% f.s.	φ15 mm (0.59 in.)	-	0°C to 50°C 32°F to 122°F	300 V CAT III
9010-50		10 A to 500 A AC	40 Hz to 1 kHz	±2% rdg. ±1% f.s.	φ46 mm (1.81 in.)	3 m (9.84 ft.)	0°C to 50°C 32°F to 122°F	600 V CAT III
9018-50		10 A to 500 A AC	40 Hz to 3 kHz	±1.5% rdg. ±0.1% f.s.	φ46 mm (1.81 in.)	3 m (9.84 ft.)	0°C to 50°C 32°F to 122°F	600 V CAT III
9132-50		20 A to 1000 A AC	40 Hz to 1 kHz	±3% rdg. ±0.2% f.s.	φ55 mm (2.17 in.)	3 m (9.84 ft.)	-10°C to 50°C 14°F to 122°F	600 V CAT III
CT6500		500 A AC	40 Hz to 1 kHz	±1.5% rdg. ±0.03% f.s.	φ46 mm (1.81 in.)	3 m (9.84 ft.)	0°C to 50°C 32°F to 122°F	600 V CAT III
9661		500 A AC	40 Hz to 5 kHz	±0.3% rdg. ±0.01% f.s.	φ46 mm (1.81 in.)	3 m (9.84 ft.)	0°C to 50°C 32°F to 122°F	600 V CAT III
9669		1000 A AC	40 Hz to 5 kHz	±1.0% rdg. ±0.01% f.s.	φ55 mm (2.17 in.)	3 m (9.84 ft.)	0°C to 50°C 32°F to 122°F	600 V CAT III
Measurement of large currents								
CT9667-01		500 A, 5000 A AC	10 Hz to 20 kHz	±2% rdg. ±0.3% f.s.	φ100 mm (3.94 in.)	2 m, 1 m*2 (6.56 ft., 3.28 ft.)	-25°C to 65°C -13°F to 149°F	600 V CAT IV 1000 V CAT III
CT9667-02		500 A, 5000 A AC	10 Hz to 20 kHz	±2% rdg. ±0.3% f.s.	φ180 mm (7.09 in.)	2 m, 1 m*2 (6.56 ft., 3.28 ft.)	-25°C to 65°C -13°F to 149°F	600 V CAT IV 1000 V CAT III
CT9667-03		500 A, 5000 A AC	10 Hz to 20 kHz	±2% rdg. ±0.3% f.s.	φ254 mm (10.00 in.)	2 m, 1 m*2 (6.56 ft., 3.28 ft.)	-10°C to 50°C 14°F to 122°F	600 V CAT IV 1000 V CAT III
Measurement of leakage current								
9657-10		10 A AC	40 Hz to 5 kHz	±1.0% rdg. ±0.05% f.s.	φ40 mm (1.57 in.)	3 m (9.84 ft.)	0°C to 50°C 32°F to 122°F	-
9675		10 A AC	40 Hz to 5 kHz	±1.0% rdg. ±0.005% f.s.	φ30 mm (1.18 in.)	3 m (9.84 ft.)	0°C to 50°C 32°F to 122°F	-

*1: The 9695-02 and 9695-03 use an M3 terminal block for their output terminals. The extra purchase of the connection cable 9219 is required.

*2: Sensor cable: between flexible loop and circuit box for flexible sensors (e.g. CT9667-01), output cable for others.

High-accuracy measurement

* Depending on the connected instruments, it may not be possible to measure up to the rated current of the current sensors.
For details, refer to the instruction manual of the connected instruments.

ME15W	Directly wired	External power supply + connection cord			Conversion cable	
CT6862-05			 <p>CT9555, CT9556 Connects one sensor</p> <p>CT9557* Connects four sensors.</p> <p>L9217 Isolated BNC</p> <p>9165 metallic BNC</p> <p>Connects CT9555, CT9556 or CT6557 and instrument.</p>			 <p>CT9901 Converts ME15W terminal to PL23 terminal</p>
CT6872						
CT6872-01						
CT6863-05						
CT6873						
CT6873-01						
CT6875A	ME15W	BNC	BNC	BNC	PL23	
CT6875A-1						
CT6904A	PW8001	PW3335-03	U8975	MR8870	8971+9318	
CT6904A-1	ME15W	BNC	BNC	BNC	The 9318 comes with the 8971	
CT6904A-2						
CT6904A-3	PW6001	PW3335-04	U8976	MR8880		
CT6876A	ME15W	BNC	BNC	BNC		
CT6876A-1						
CT6877A	PW3390	PW3336	U8978	MR8875 + MR8901		
CT6877A-1	ME15W	BNC	BNC			
9272-05						
CT6841A	U8977	PW3337	8966			
CT6843A			BNC			
CT6844A						
CT6845A			8968			
CT6846A			BNC			
PW9100A-3						
PW9100A-4	CT9902 (ME15W-ME15W)		8972			

*The CT9557 can output four channels of input as an added waveform.

CT9557 Front



Sensor input

Rear



1 2 3

1	Total RMS output (BNC)	CONNECTION CABLE L9217, 9165 BNC-BNC
2	Total waveform output (BNC)	CONNECTION CABLE L9217, 9165 BNC-BNC
3	Total waveform output (ME15W)	CONNECTION CABLE CT9904 ME15W-ME15W

We accept special orders for extending sensor cables. For inquiries, please contact Hioki for more information.

The CT9902 can be used to extend a current sensor's cable by 5 m. Up two of these cables can be used for a maximum extension of 10 m.

*When using the CT9902, an addition must be made to accuracy. For details, see the sensor's user manual.

Waveform observation

* Depending on the connected instruments, it may not be possible to measure up to the rated current of the current sensors. For details, refer to the instruction manual of the connected instruments.

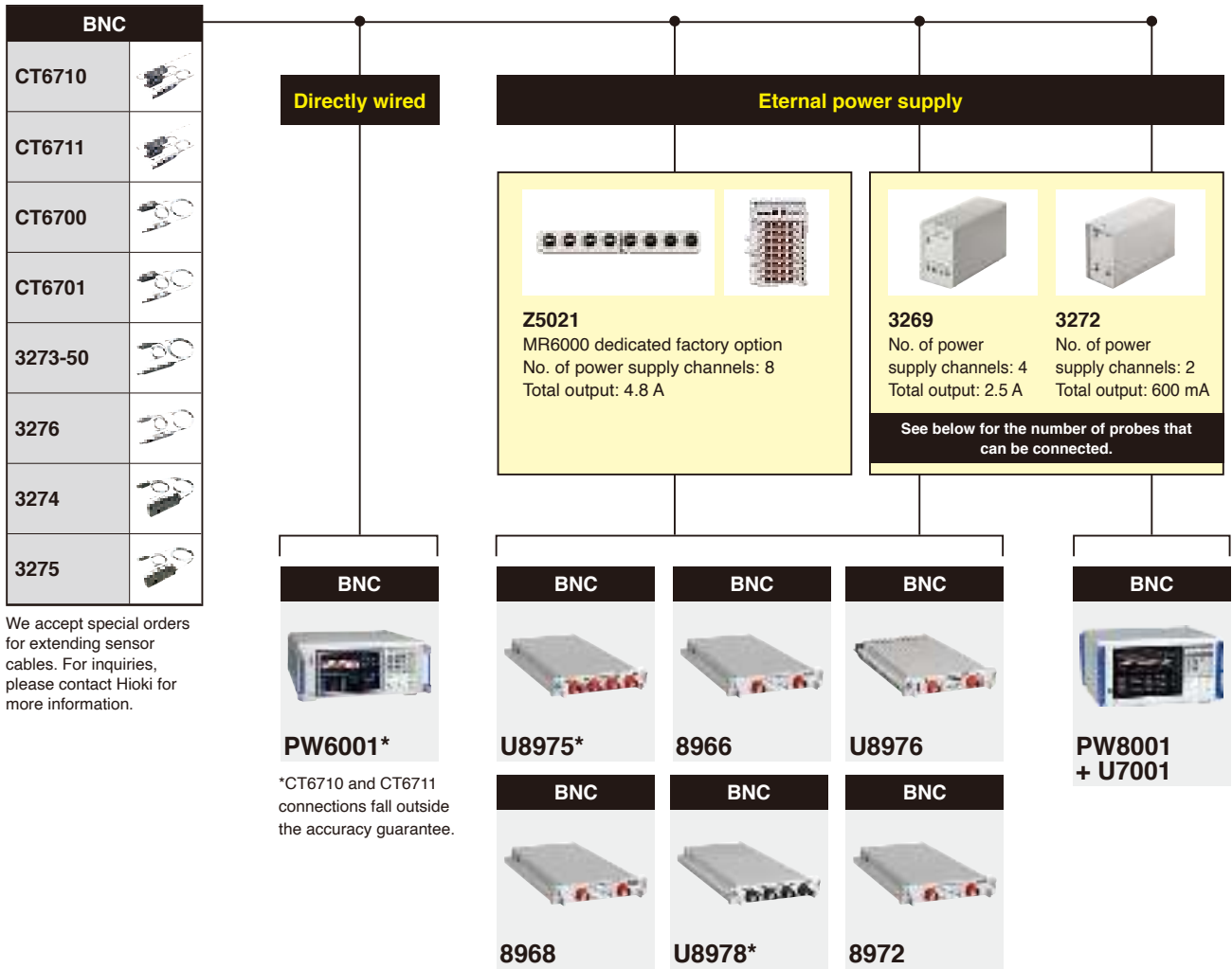

We accept special orders for extending sensor cables. For inquiries, please contact Hioki for more information.

PW6001*
*CT6710 and CT6711 connections fall outside the accuracy guarantee.

*Special-order cables are required when using three or more probes simultaneously. Please contact Hioki for details.

The following products can be used with the U8975, U8976, U8978, 8966, 8968, and 8972

	U8975	✓		U8975	✓		U8975	-
	U8976	✓		U8976	-		U8976	-
	U8977	✓		U8977	✓		U8977	-
	U8978	✓		U8978	✓		U8978	-
	8966	✓		8966	✓		8966	✓
	8968	✓		8968	✓		8968	✓
	8971	✓		8971	✓		8971	✓
	8972	✓		8972	✓		8972	✓
	U8975	✓		U8975	-		U8975	-
	U8976	-		U8976	-		U8976	-
	U8977	✓		U8977	-		U8977	-
	U8978	✓		U8978	-		U8978	-
	8966	✓		8966	✓		8966	✓
	8968	✓		8968	✓		8968	✓
	8971	✓		8971	✓		8971	-
	8972	✓		8972	✓		8972	✓

Current consumption per probe and number of probes per power supply

Current consumption varies by probe. The following table indicates how many probes can be utilized when using one type of probe per power supply.

Sensor	Consumption current*	Z5021	3269	3272
CT6710	approx. 650 mA	4	2	-
CT6711	approx. 650 mA	4	2	-
CT6700	approx. 250 mA	8	4	2
CT6701	approx. 250 mA	8	4	2
3273-50	approx. 450 mA	8	4	1
3274	approx. 450 mA	8	4	1
3275	approx. 600 mA	8	4	1
3276	approx. 450 mA	8	4	1

*When measuring the rated current.

Grid power quality control (PL14)

* Depending on the connected instruments, it may not be possible to measure up to the rated current of the current sensors. For details, refer to the instruction manual of the connected instruments.

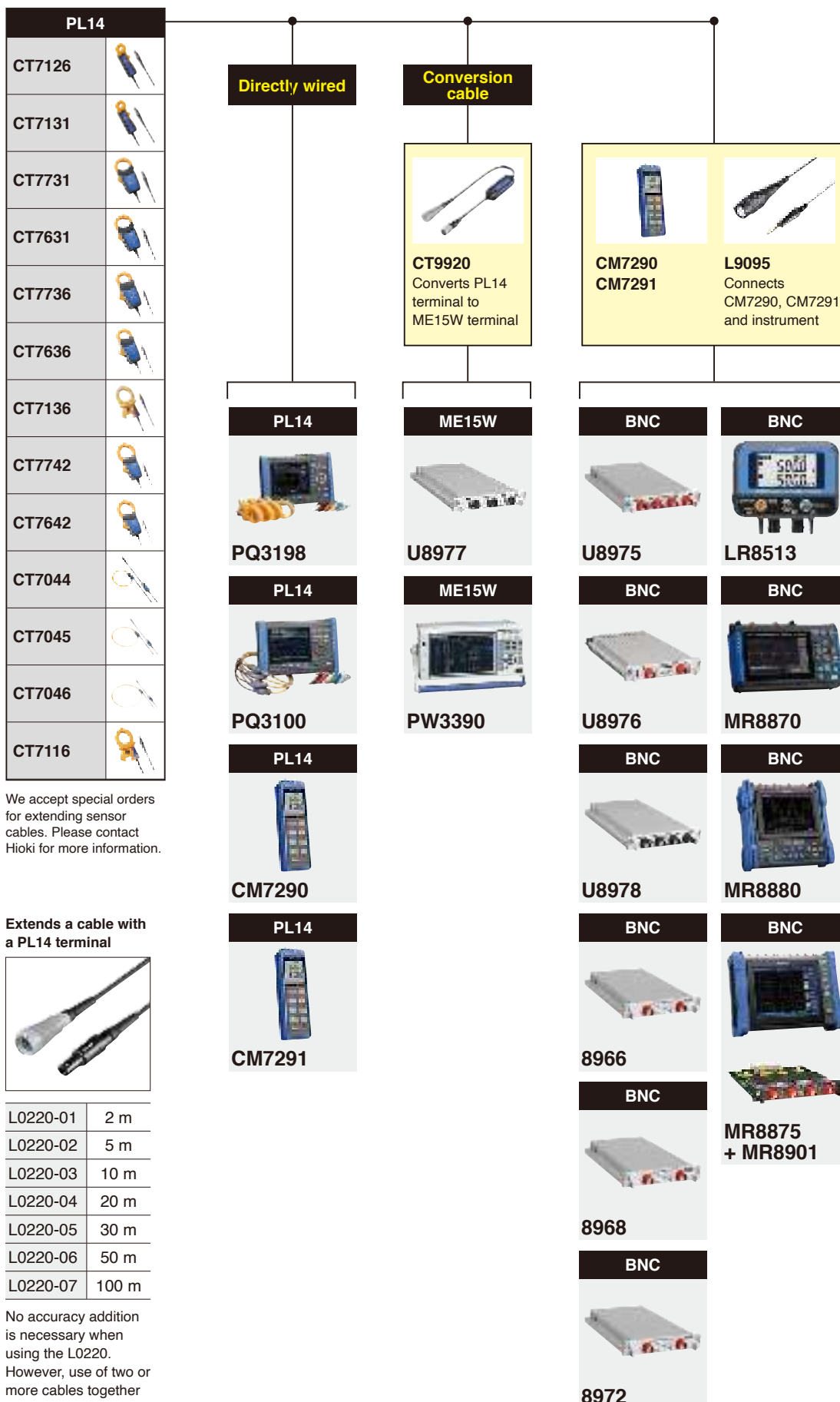

Grid power quality control (BNC)

* Depending on the connected instruments, it may not be possible to measure up to the rated current of the current sensors. For details, refer to the instruction manual of the connected instruments.

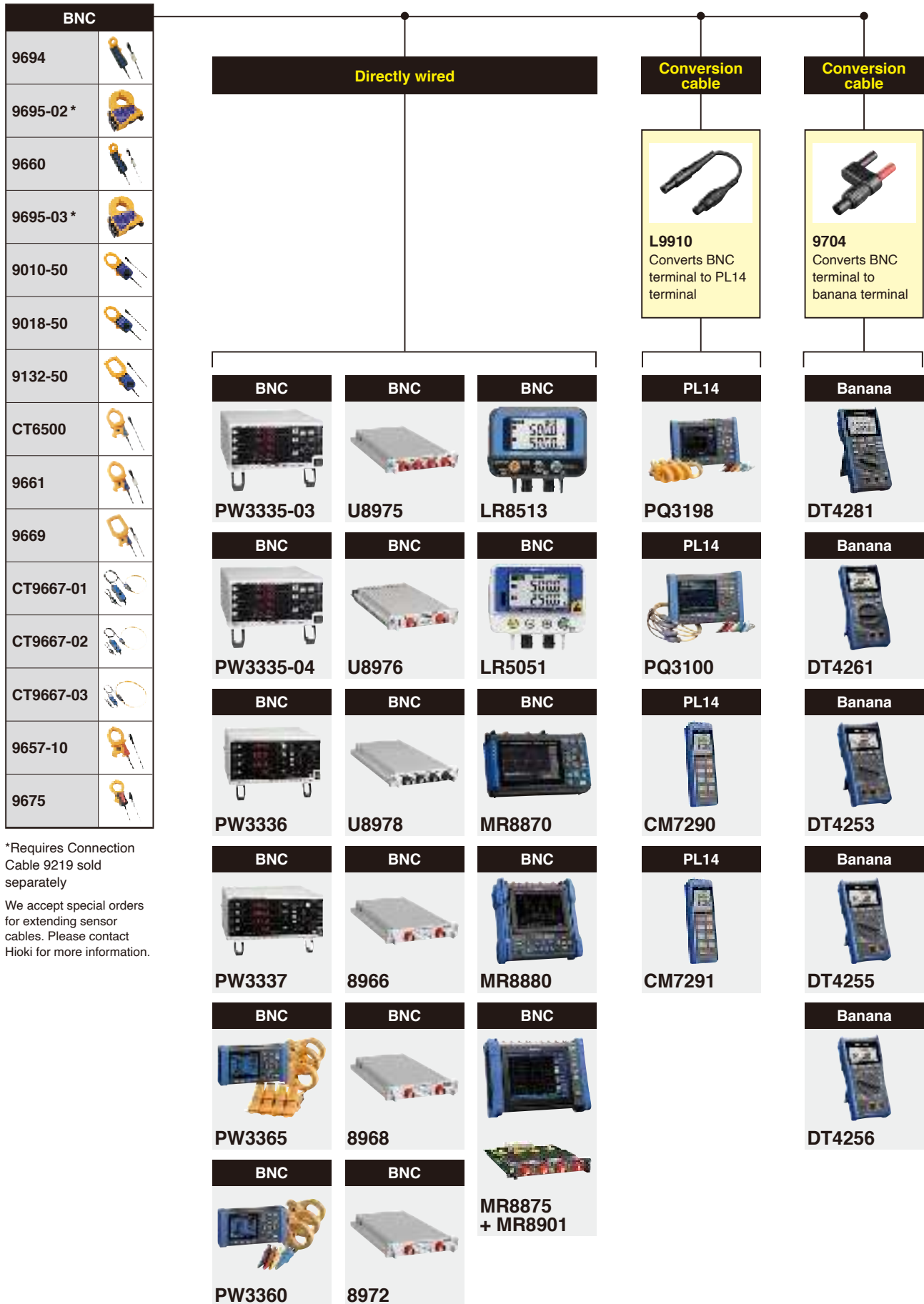

*Requires Connection Cable 9219 sold separately
 We accept special orders for extending sensor cables. Please contact Hioki for more information.

Accurately evaluating power conversion efficiency

Improving power conversion efficiency is a key part of the effort to facilitate the effective use of energy. Devices that operate at high frequencies are increasingly being used to improve efficiency, and evaluation processes undertaken during the development of such devices requires accurate measurement of power at the low frequencies used by in previous devices as well as at high frequencies. Additionally, sensors that can resist noise are necessary since noise becomes stronger as the frequency increases. Hioki offers current sensors that can measure power accurately while providing robust noise resistance over a broad band of frequencies.

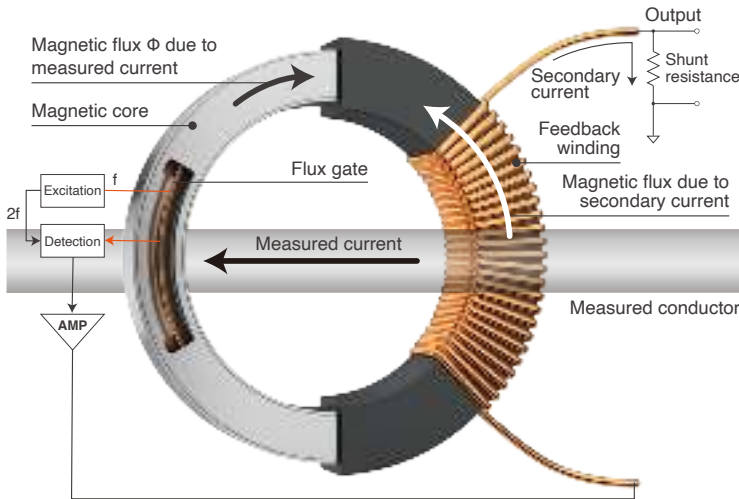

High-frequency currents are detected by a winding (CT), while DC to low-frequency currents are detected by a flux gate.

Zero-flux method: achieving stable, wideband measurement from DC to high frequencies

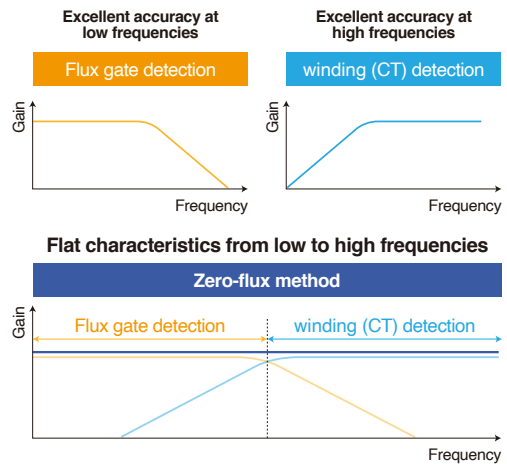

Zero-flux method (flux gate) current sensors



Application

Evaluating the power conversion efficiency of an inverter

When evaluating the power conversion efficiency of an inverter, the inverter's input and output power are measured and its efficiency is checked. PWM (pulse width modulated) inverter output, which has been widely used in recently years, contains a modulated wave (fundamental wave) and a switching frequency along with their respective harmonic components. Since switching frequencies tend to be high, the process requires wide frequency band current sensors.

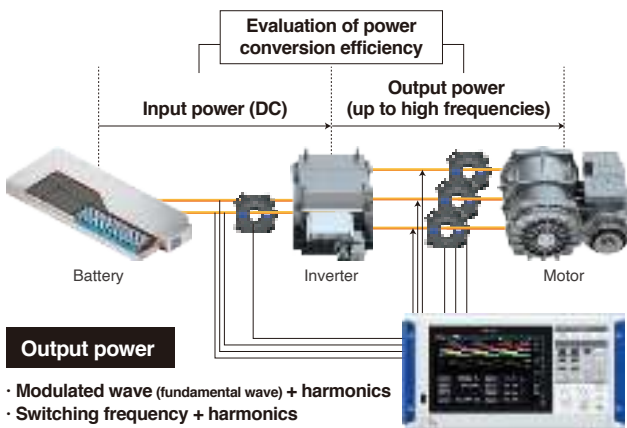

Inverter output: principal active power components

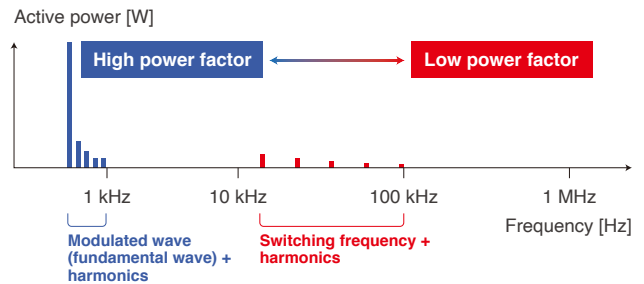

Since the power factor decreases with harmonics, current sensors' phase measurement accuracy becomes key (see right).

Phase measurement accuracy and correction: accurately measuring power at low power factors

For typical current sensors, phase measurement accuracy is not defined. However, phase measurement precision is important in applications where power must be measured with a high degree of accuracy. Power can be measured more accurately by selecting a current sensor for which phase measurement accuracy is defined in the measurement band.

At low power factors, phase error has a significant effect on power error.

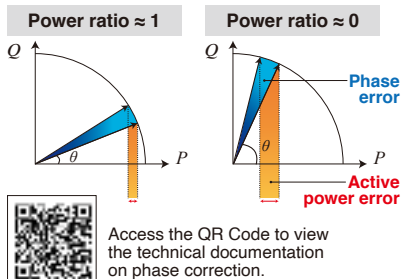

PW8001: Automatic Phase Correction function
Automatic acquisition of phase correction values

Power supplied from instrument

Information stored in the current sensors' internal memory

Phase shift	Rated current
Sensor model	Serial number

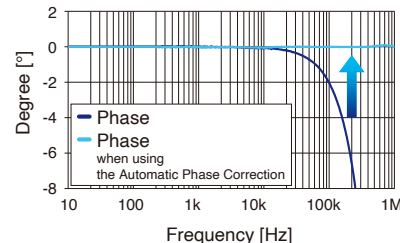

Example of the Automatic Phase Correction for the CT6904A AC/DC current sensor

The power factor decreases in the high-frequency range of the switching frequencies and other frequency components. At low power factors, phase error has a significant effect on power measured values.

For typical sensors, phase error increases with frequency. Since Hioki has developed both current sensors and the measuring instruments, current sensors' phase characteristics can be corrected by the instruments, allowing accurate power values to be calculated.

Common-mode voltage rejection ratio: measuring current values accurately in noisy environments

In high-frequency measurement, sensors' resistance to noise is critical. A sensor's ability to remove noise is expressed by its common-mode rejection ratio (CMRR). Sensors with a high CMRR reject more noise and therefore can make more accurate measurements.

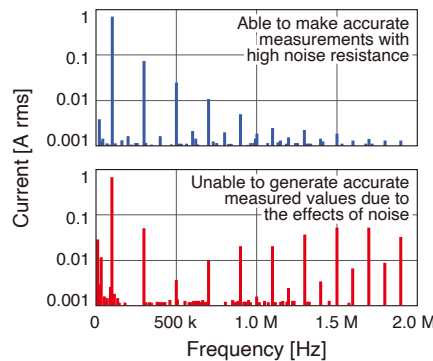
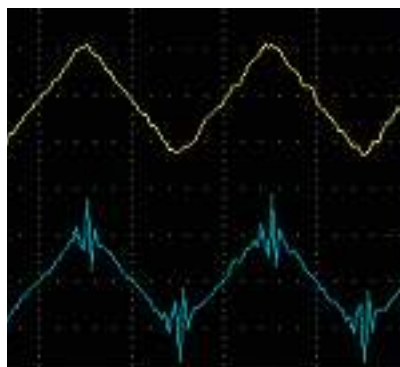
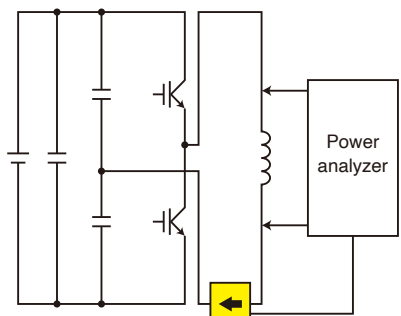

For reactors, higher frequencies mean lower current values. The image to the right shows a waveform obtained by measuring reactor current at high frequency along with variations in current values that accompany variations in the frequency.

Top: CT6904A CMRR 120 dB or greater (100 Hz); bottom: sensor with a low CMRR

Effects of conductor position: stable, highly reproducible sensing

In general, speaking, the effects of conductor position increase with frequency. Since the position of the conductor inside the clamp core affects the measurement accuracy, resulting the reproducibility of measurement reduces. Sensors are designed the effects of conductor position, highly reproducible measurements are possible since conductor position does not affect measured values.

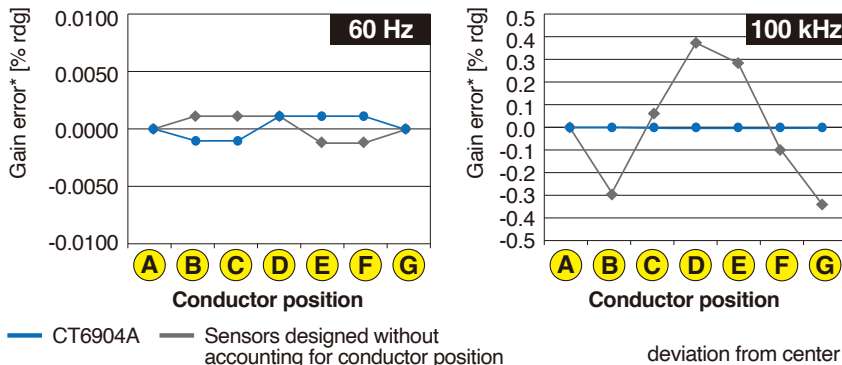

When using a sensor designed with the effects of conductor position, measured values are not affected when the conductor's position changes.

Clearly observing current waveforms

The magnitude of the currents that flow in power-saving devices during operation and control currents that flow in automotive accessory components have reduced to 1 mA or less. At the same time, reliance on high-speed switching operation for device control is resulting in increased noise. Wideband current probes that are highly resistant to noise are essential in order to clearly observe low-current waveforms without losing them in noise. Hioki offers current probes that enable clear waveform observation while providing robust noise resistance over a broad band of frequencies.

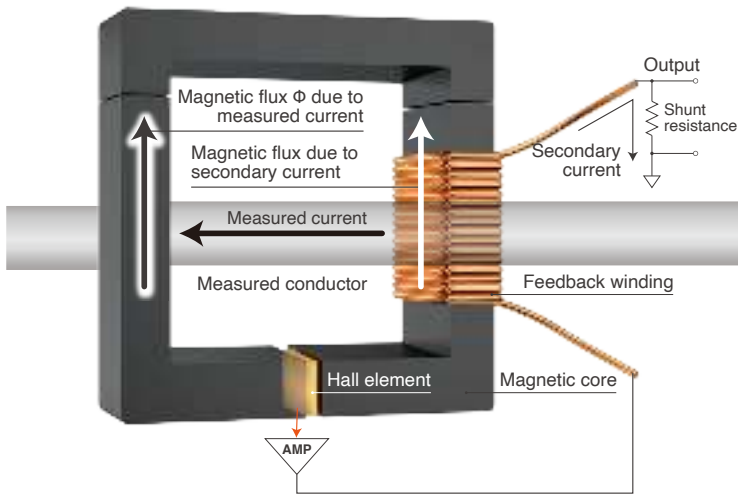

High-frequency currents are detected by the winding (CT), while DC to low-frequency currents are detected by the Hall element.

Zero-flux method: realizing stable, wideband measurement from DC to high frequencies

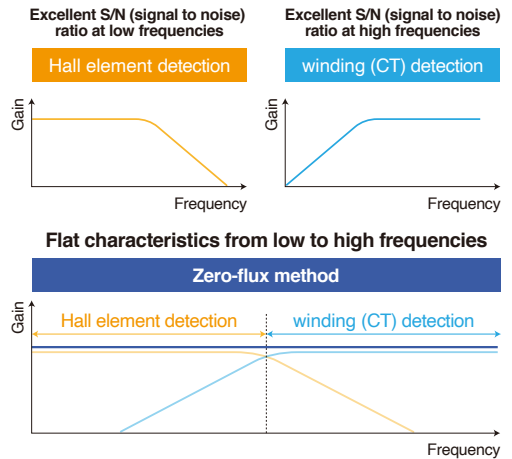

Zero-flux method (hall element) current probes

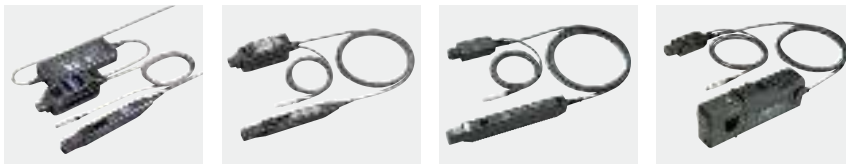

CT6710, CT6711

CT6700, CT6701

3273-50, 3276

3274, 3275

Application

Evaluating the response performance of switching devices

Switching devices control equipment by turning the power on and off. The response performance of switching devices is evaluated by observing fluctuations of current and voltage when the device cycles the power on and off. Capturing current fluctuations caused by high-speed switching operation requires current probes with a broad frequency band. Additionally, noise resistance is important since switching operation generates noise.

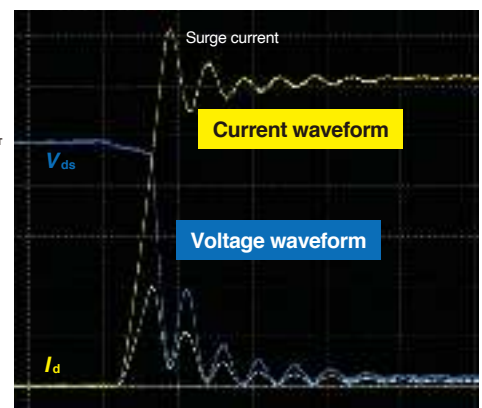
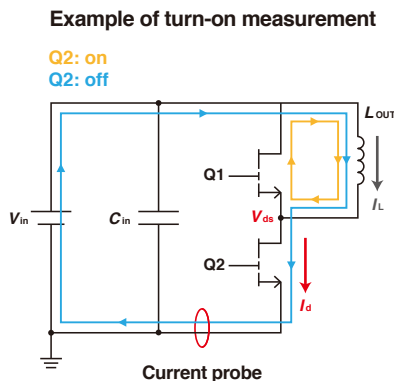
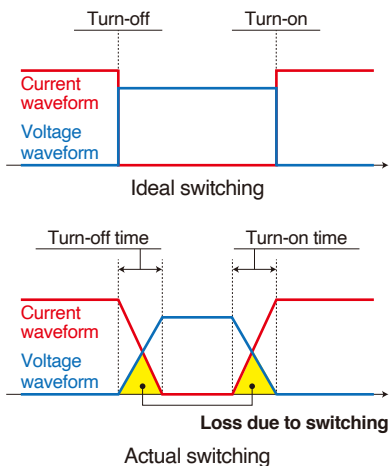

Observing waveforms from minuscule currents to large currents: evaluating the control design of ECUs and accessory components

The control systems used in ECUs and accessory components carry currents of a variety of magnitudes according to the vehicle's operation, from control currents to inrush currents. Using a current probe that can switch current ranges makes it possible to observe current waveforms associated with an array of operating conditions with a single probe.

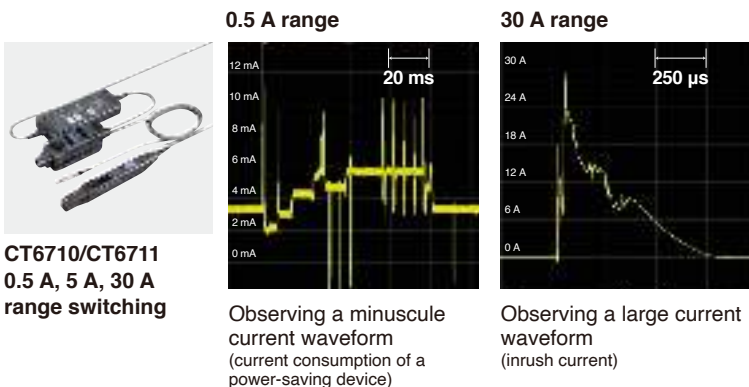

CT6710/CT6711
0.5 A, 5 A, 30 A range switching

Observing a minuscule current waveform (current consumption of a power-saving device)

Observing a large current waveform (inrush current)

Model	Freq. band	measurement range	output rate
CT6710	DC to 50 MHz	0.5 A	10 V/A
		5 A	1 V/A
		30 A	0.1 V/A
CT6711	DC to 120 MHz	0.5 A	10 V/A
		5 A	1 V/A
		30 A	0.1 V/A
CT6700	DC to 50 MHz	5 A	1 V/A
CT6701	DC to 120 MHz	5 A	1 V/A
3273-50	DC to 50 MHz	30 A	0.1 V/A
3276	DC to 100 MHz	30 A	0.1 V/A
3274	DC to 10 MHz	150 A	0.01 V/A
3275	DC to 2 MHz	500 A	0.01 V/A

Observing currents of a variety of magnitudes, from minuscule currents to large currents, with a single probe

Clearly observing minuscule currents: operating currents of power-saving devices and control currents flowing to accessory components

The magnitude of the currents that flow during operation of power-saving devices like wearables and control currents that flow in automotive accessory components tend to decrease in to 1 mA or less. Using a current probe with a high output rate make you possible for clearly observing minuscule current waveforms.

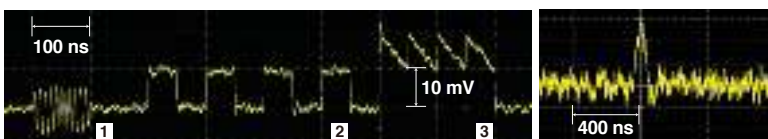

CT6710, CT6711 Output rate of 10 V/A lets you observe clear waveforms with a high S/N ratio.

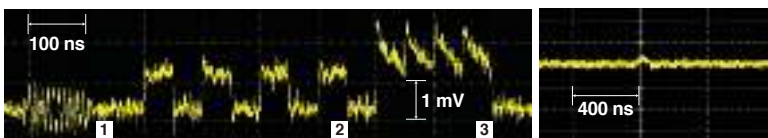

Earlier model Output rate of 1 V/A precludes observation of accurate waveforms as they are obscured by noise.

- 1 Sine wave: $f = 100$ MHz, 1 mA peak-peak
- 2 Square wave: $f = 10$ MHz, 1 mA peak-peak
- 3 Sawtooth wave: $f = 20$ MHz, 1 mA peak-peak (offset +1 mA)

Noise resistance design: key to increasing output rate



Hioki uses a proprietary thin-film Hall element to reduce the amount of noise generated inside the probe. Electromagnetic shielding in the sensor improves resistance to environmental noise.

Observing waveforms across a broad band of frequencies: capturing waveforms and pulse waveforms that fluctuate at high speeds

Currents from switching operation of devices such as SiC and GaN inverters and currents that flow momentarily when a power supply is activated fluctuate at high speeds. Using a current probe with a wide frequency band allows you observe current waveforms that fluctuate at high speed. Additionally, such devices allow you observe current waveforms such as pulse waveforms that contain a variety of frequency components.

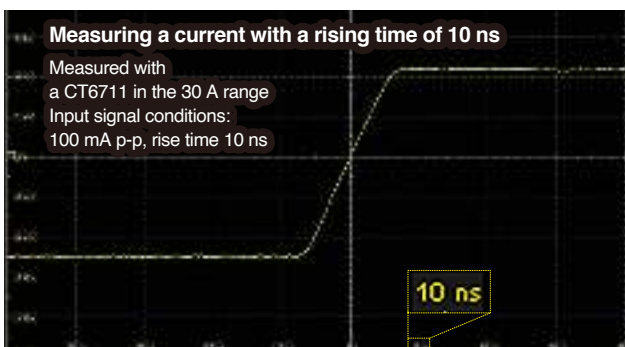

Current probes with a wide frequency band can capture high-speed current fluctuations with a rising time of 10 ns.

Failure to capture accurate waveforms due to insufficient frequency band
Example of measuring a pulse with a cyclic frequency of 1 MHz using different frequency bands

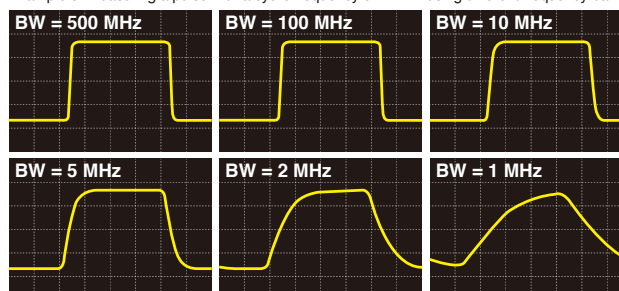

Current probes with a wide frequency band can accurately capture pulse waveforms.

CT6862-05



Product warranty period: 3 years
Guaranteed accuracy period: 1 year

Rated current	50 A AC/DC
Frequency band	DC to 1 MHz (-3 dB)
Diameter of measurable conductors	Max. ϕ 24 mm (0.94 in.)

Accuracy

Frequency	Amplitude \pm (% of reading + % of full scale)	Phase
DC	$\pm 0.05\% \pm 0.01\%$	-
DC < f \leq 16 Hz	$\pm 0.10\% \pm 0.02\%$	$\pm 0.3^\circ$
16 Hz < f \leq 400 Hz	$\pm 0.05\% \pm 0.01\%$	$\pm 0.2^\circ$
400 Hz < f \leq 1 kHz	$\pm 0.2\% \pm 0.02\%$	$\pm 0.5^\circ$
1 kHz < f \leq 5 kHz	$\pm 0.7\% \pm 0.02\%$	$\pm 1.0^\circ$
5 kHz < f \leq 10 kHz	$\pm 1\% \pm 0.02\%$	$\pm 1.0^\circ$
10 kHz < f \leq 50 kHz	$\pm 1\% \pm 0.02\%$	$\pm (0.5 + 0.1 \times f \text{ kHz})^\circ$
50 kHz < f \leq 100 kHz	$\pm 2\% \pm 0.05\%$	$\pm (0.5 + 0.1 \times f \text{ kHz})^\circ$
100 kHz < f \leq 300 kHz	$\pm 5\% \pm 0.05\%$	$\pm (0.5 + 0.1 \times f \text{ kHz})^\circ$
300 kHz < f \leq 700 kHz	$\pm 10\% \pm 0.05\%$	-
700 kHz < f < 1 MHz	$\pm 30\% \pm 0.05\%$	-

The values above are when the input is a sine wave, the conductor is in the center of the sensor opening, and the measurement instrument's input resistance is 1 M Ω or higher.
Amplitude accuracy: defined at the rated value or less, or within the derating curve; DC < f < 5 Hz is the typical value by design.
Phase accuracy: defined at the rated value or less, or within the derating curve; DC < f < 10 Hz is the typical value by design.

Temperature and humidity range for guaranteed accuracy	0°C to 40°C (32°F to 104°F), 80% RH or less
Effect of temperature	In ranges from -30°C to 0°C (-22°F to 32°F) and 40°C to 85°C (104°F to 185°F) Amplitude sensitivity: $\pm 0.005\%$ of reading/°C or less Offset voltage: $\pm 0.005\%$ of full scale/°C or less
Effect of common mode voltage	0.05% of full scale or less (1000 Vrms, DC to 100 Hz)

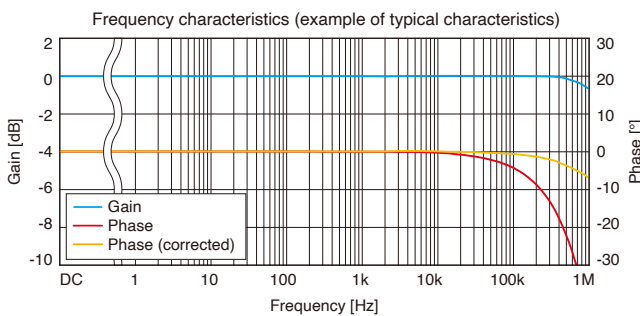
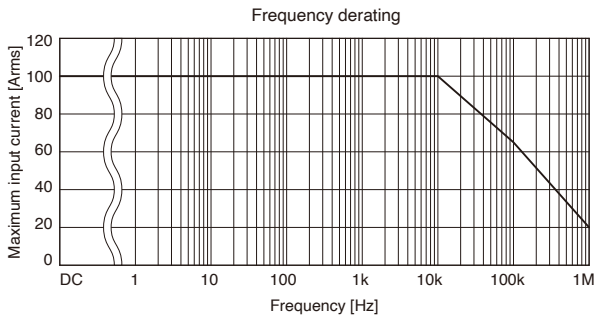

Output voltage	40 mV/A (= 2 V/50 A)
Operating temperature and humidity range	-30°C to 85°C (-22°F to 185°F), 80% RH or less (no condensation)
Storage temperature and humidity range	-30°C to 85°C (-22°F to 185°F), 80% RH or less (no condensation)
Maximum rated voltage to ground	1000 V AC/DC (50/60 Hz), measurement category III, anticipated transient overvoltage: 8000 V
Standards	Safety: EN61010, EMC: EN61326
Cable length	3 m (9.84 ft.)
Dimensions	70 mm (2.76 in.) W x 100 mm (3.94 in.) H x 53 mm (2.09 in.) D (Excluding protruding parts and cables)
Weight	Approx. 340 g (12.0 oz.)

CT6872 CT6872-01

NEW



Product warranty period: 3 years
Guaranteed accuracy period: 1 year

Rated current	50 A AC/DC
Frequency band	DC to 10 MHz (-3 dB)
Diameter of measurable conductors	Max. ϕ 24 mm (0.94 in.)

Accuracy

Frequency	Amplitude \pm (% of reading + % of full scale)	Phase
DC	$\pm 0.03\% \pm 0.002\%$	-
DC < f \leq 16 Hz	$\pm 0.1\% \pm 0.01\%$	$\pm 0.1^\circ$
16 Hz < f \leq 45 Hz	$\pm 0.05\% \pm 0.01\%$	$\pm 0.08^\circ$
45 Hz < f \leq 66 Hz	$\pm 0.03\% \pm 0.007\%$	$\pm 0.05^\circ$
66 Hz < f \leq 100 Hz	$\pm 0.04\% \pm 0.01\%$	$\pm 0.1^\circ$
100 Hz < f \leq 500 Hz	$\pm 0.06\% \pm 0.01\%$	$\pm 0.15^\circ$
500 Hz < f \leq 1 kHz	$\pm 0.1\% \pm 0.01\%$	$\pm 0.4^\circ$
1 kHz < f \leq 5 kHz	$\pm 0.15\% \pm 0.02\%$	$\pm 0.4^\circ$
5 kHz < f \leq 10 kHz	$\pm 0.15\% \pm 0.02\%$	$\pm 0.5^\circ$
10 kHz < f \leq 1 MHz	$(0.012 \times f \text{ kHz})\% + 0.05\%$	$\pm (0.04 \times f \text{ kHz})^\circ \pm 0.1^\circ$

Combined accuracy with HIOKI power analyzer PW8001, PW6001 and PW3390 is specified (DC, 45 Hz \leq f \leq 66 Hz). For details of combined accuracy, refer to the instruction manual.
The values above are when the input is a sine wave, the measuring instrument has an input resistance of 1 M Ω \pm 10%, the voltage to ground is 0 V, there is no external magnetic field, and the conductor is in the center of the sensor opening.
Amplitude accuracy: defined 110% of full scale or less, or within the derating curve; DC < f < 10 Hz is the value by design.
Phase accuracy: defined 110% of full scale or less, or within the derating curve; DC < f < 10 Hz is the value by design.
Add $\pm 0.01\%$ of reading to the amplitude accuracy for input from 100% of full scale to 110% of full scale.
The CT6872-01 adds a phase accuracy of $\pm(0.015 \times f)$ at a frequency of 1 kHz \leq f \leq 1 MHz.

Temperature and humidity range for guaranteed accuracy	23°C \pm 5°C (73.4°F \pm 41°F), 80% RH or less
Effect of temperature	In ranges from -40°C to 18°C (-40°F to 64.4°F) and 28°C to 85°C (82.4°F to 185°F) Amplitude sensitivity: ± 20 ppm of reading/°C Offset voltage: ± 0.2 ppm of full scale/°C
Common-Mode Rejection Ratio (CMRR)	(effect on output voltage and common mode voltage) 150 dB or greater (DC to 1 kHz) 140 dB or greater (1 kHz to 10 kHz) 120 dB or greater (10 kHz to 100 kHz) 100 dB or greater (100 kHz to 1 MHz)
Linearity error	± 2 ppm
Offset error	± 5 ppm
Amplitude errors	DC: 7 ppm 10 Hz to 100 Hz: 0.005% 100 Hz to 1 kHz: 0.01% 1 kHz to 50 kHz: 0.1% 50 kHz to 100 kHz: 0.3% 100 kHz to 300 kHz: 1% 300 kHz to 1 MHz: 3%

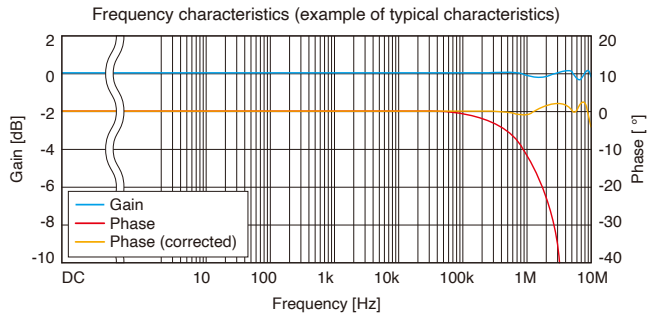
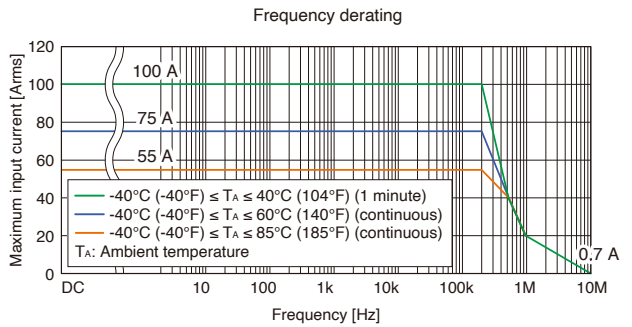

Output voltage	40 mV/A (= 2 V / 50 A)
Operating temperature and humidity range	-40°C to 85°C (-40°F to 185°F), 80% RH or less (no condensation)
Storage temperature and humidity range	-40°C to 85°C (-40°F to 185°F), 80% RH or less (no condensation)
Maximum rated voltage to ground	1000 V CAT III Anticipated transient overvoltage: 8000 V
Standards	Safety: EN61010, EMC: EN61326
Cable length	CT6872: 3 m (9.84 ft.) CT6872-01: 10 m (32.81 ft.)
Dimensions	70 mm (2.76 in.) W x 110 mm (4.33 in.) H x 53 mm (2.09 in.) D (excluding protruding parts and cables)
Weight	CT6872: approx. 370 g (13.1 oz.) CT6872-01: approx. 690 g (24.3 oz.)

CT6863-05



Product warranty period: 3 years
Guaranteed accuracy period: 1 year

Rated current	200 A AC/DC
Frequency band	DC to 500 kHz (-3 dB)
Diameter of measurable conductors	Max. φ 24 mm (0.94 in.)

Accuracy

Frequency	Amplitude ±(% of reading + % of full scale)	Phase
DC	±0.05% ±0.01%	-
DC < f ≤ 16 Hz	±0.10% ±0.02%	±0.3°
16 Hz < f ≤ 400 Hz	±0.05% ±0.01%	±0.2°
400 Hz < f ≤ 1 kHz	±0.2% ±0.02%	±0.5°
1 kHz < f ≤ 5 kHz	±0.7% ±0.02%	±1.0°
5 kHz < f ≤ 10 kHz	±1% ±0.02%	±1.0°
10 kHz < f ≤ 50 kHz	±2% ±0.02%	±(0.5 + 0.1 × f kHz)°
50 kHz < f ≤ 100 kHz	±5% ±0.05%	±(0.5 + 0.1 × f kHz)°
100 kHz < f ≤ 300 kHz	±10% ±0.05%	±(0.5 + 0.1 × f kHz)°
300 kHz < f ≤ 500 kHz	±30% ±0.05%	-

The values above are when the input is a sine wave, the conductor is in the center of the sensor opening, and the measurement instrument's input resistance is 1 MΩ or higher. Amplitude accuracy: defined at the rated value or less, or within the derating curve; DC < f < 5 Hz is the typical value by design. Phase accuracy: defined at the rated value or less, or within the derating curve; DC < f < 10 Hz is the typical value by design.

Temperature and humidity range for guaranteed accuracy	0°C to 40°C (32°F to 104°F), 80% RH or less
Effect of temperature	In ranges from -30°C to 0°C (-22°F to 32°F) and 40°C to 85°C (104°F to 185°F) Amplitude sensitivity: ±0.005% of reading/°C or less Offset voltage: ±0.005% of full scale/°C or less
Effect of common mode voltage	0.05% of full scale or less (1000 Vrms, DC to 100 Hz)

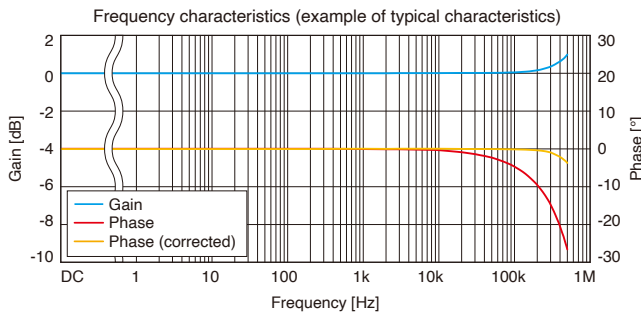
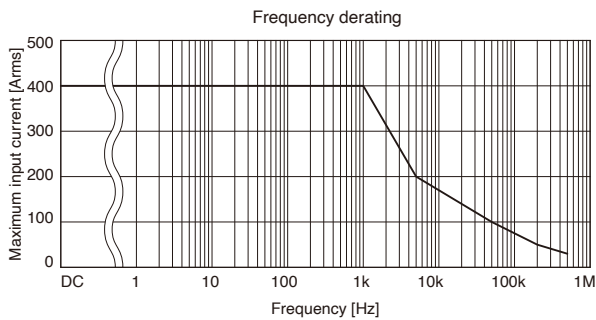

Output voltage	10 mV/A (= 2 V / 200 A)
Operating temperature and humidity range	-30°C to 85°C (-22°F to 185°F), 80% RH or less (no condensation)
Storage temperature and humidity range	-30°C to 85°C (-22°F to 185°F), 80% RH or less (no condensation)
Maximum rated voltage to ground	1000 V AC/DC (50/60 Hz), measurement category III, anticipated transient overvoltage: 8000 V
Standards	Safety: EN61010, EMC: EN61326
Cable length	3 m (9.84 ft.)
Dimensions	70 mm (2.76 in.) W × 100 mm (3.94 in.) H × 53 mm (2.09 in.) D (excluding protruding parts and cables)
Weight	Approx. 340 g (12.0 oz.)

CT6873 CT6873-01

NEW



Product warranty period: 3 years
Guaranteed accuracy period: 1 year

Rated current	200 A AC/DC
Frequency band	DC to 10 MHz (-3 dB)
Diameter of measurable conductors	Max. φ 24 mm (0.94 in.)

Accuracy

Frequency	Amplitude ±(% of reading + % of full scale)	Phase
DC	±0.03% ±0.002%	-
DC < f ≤ 16 Hz	±0.1% ±0.01%	±0.1°
16 Hz < f ≤ 45 Hz	±0.05% ±0.01%	±0.08°
45 Hz < f ≤ 66 Hz	±0.03% ±0.007%	±0.05°
66 Hz < f ≤ 100 Hz	±0.04% ±0.01%	±0.1°
100 Hz < f ≤ 500 Hz	±0.05% ±0.01%	±0.15°
500 Hz < f ≤ 3 kHz	±0.1% ±0.01%	±0.4°
3 kHz < f ≤ 5 kHz	±0.2% ±0.02%	±0.4°
5 kHz < f ≤ 10 kHz	±0.2% ±0.02%	±0.5°
10 kHz < f ≤ 1 MHz	(0.018 × f kHz)% + 0.05%	±(0.04 × f kHz)° ±0.1°

Combined accuracy with HIOKI power analyzer PW8001, PW6001 and PW3390 is specified (DC, 45 Hz ≤ f ≤ 66 Hz). For details of combined accuracy, refer to the instruction manual. The values above are when the input is a sine wave, the measuring instrument has an input resistance of 1 MΩ ±10%, the voltage to ground is 0 V, there is no external magnetic field, and the conductor is in the center of the sensor opening. Amplitude accuracy: defined 110% of full scale or less, or within the derating curve; DC < f < 10 Hz is the value by design. Phase accuracy: defined 110% of full scale or less, or within the derating curve; DC < f < 10 Hz is the value by design. Add ±0.01% of reading to the amplitude accuracy for input from 100% of full scale to 110% of full scale. The CT6873-01 adds a phase accuracy of ±(0.015 × f)° at a frequency of 1 kHz < f ≤ 1 MHz.

Temperature and humidity range for guaranteed accuracy	23°C ±5°C (73.4°F ±41°F), 80% RH or less
Effect of temperature	In ranges from -40°C to 18°C (-40°F to 64.4°F) and 28°C to 85°C (82.4°F to 185°F) Amplitude sensitivity: ±15 ppm of reading/°C Offset voltage: ±0.1 ppm of full scale/°C
Common-Mode Rejection Ratio (CMRR)	(effect on output voltage and common mode voltage) 150 dB or greater (DC to 1 kHz) 140 dB or greater (1 kHz to 10 kHz) 120 dB or greater (10 kHz to 100 kHz) 100 dB or greater (100 kHz to 1 MHz)
Linearity errors	±2 ppm
Offset error	±5 ppm
Amplitude error	DC: ±7 ppm 10 Hz to 500 Hz: ±0.005% 500 Hz to 3 kHz: ±0.01% 3 kHz to 30 kHz: ±0.1% 30 kHz to 100 kHz: ±0.4% 100 kHz to 400 kHz: ±1% 400 kHz to 1 MHz: ±3%

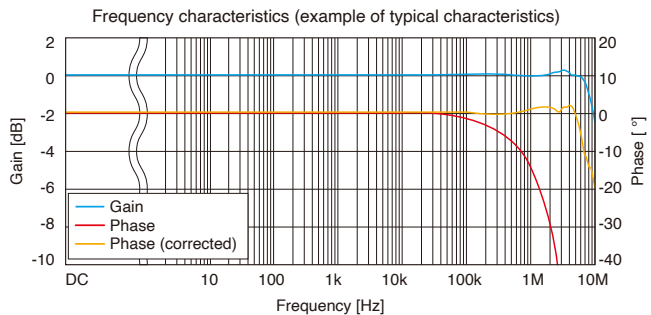
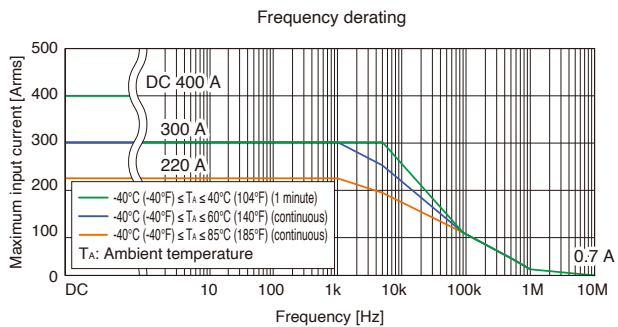

Output voltage	10 mV/A (= 2 V / 200 A)
Operating temperature and humidity range	-40°C to 85°C (-40°F to 185°F), 80% RH or less (no condensation)
Storage temperature and humidity range	-40°C to 85°C (-40°F to 185°F), 80% RH or less (no condensation)
Maximum rated voltage to ground	1000 V CAT III Anticipated transient overvoltage: 8000 V
Standards	Safety: EN61010, EMC: EN61326
Cable length	CT6873: 3 m (9.84 ft.) CT6873-01: 10 m (32.81 ft.)
Dimensions	70 mm (2.76 in.) W × 110 mm (4.33 in.) H × 53 mm (2.09 in.) D (excluding protruding parts and cables)
Weight	CT6873: approx. 370 g (13.1 oz.) CT6873-01: approx. 690 g (24.3 oz.)

CT6875A CT6875A-1



Product warranty period: 3 years
Guaranteed accuracy period: 1 year

Rated current	500 AAC/DC
Frequency band	CT6875A: DC to 2 MHz (± 3 dB) CT6875A-1: DC to 1.5 MHz (± 3 dB)
Diameter of measurable conductors	Max. ϕ 36 mm (1.41 in.)

Accuracy

Frequency	Amplitude \pm (% of reading + % of full scale)	Phase
DC	$\pm 0.04\% \pm 0.008\%$	-
DC < f < 16 Hz	$\pm 0.1\% \pm 0.02\%$	$\pm 0.1^\circ$
16 Hz \leq f < 45 Hz	$\pm 0.05\% \pm 0.01\%$	$\pm 0.1^\circ$
45 Hz \leq f \leq 66 Hz	$\pm 0.04\% \pm 0.008\%$	$\pm 0.08^\circ$
66 Hz < f \leq 100 Hz	$\pm 0.05\% \pm 0.01\%$	$\pm 0.1^\circ$
100 Hz < f \leq 500 Hz	$\pm 0.1\% \pm 0.02\%$	$\pm 0.2^\circ$
500 Hz < f \leq 1 kHz	$\pm 0.2\% \pm 0.02\%$	$\pm 0.4^\circ$
1 kHz < f \leq 5 kHz	$\pm 0.4\% \pm 0.02\%$	$\pm 0.5^\circ$
5 kHz < f \leq 10 kHz	$\pm 0.4\% \pm 0.02\%$	$\pm(0.1 \times f \text{ kHz})^\circ$
10 kHz < f \leq 50 kHz	$\pm 1.5\% \pm 0.05\%$	$\pm(0.1 \times f \text{ kHz})^\circ$
50 kHz < f \leq 100 kHz	$\pm 2.5\% \pm 0.05\%$	$\pm(0.1 \times f \text{ kHz})^\circ$
100 kHz < f \leq 1 MHz	$\pm(0.025 \times f \text{ kHz})\% \pm 0.05\%$	$\pm(0.1 \times f \text{ kHz})^\circ$

Combined accuracy with HIOKI power analyzer PW8001, PW6001 and PW3390 is specified (DC, 45 Hz \leq f \leq 66 Hz). For details of combined accuracy, refer to the instruction manual.
Amplitude accuracy: defined 110% of full scale or less, or within the derating curve; DC < f < 10 Hz is the value by design.
Add $\pm 0.01\%$ of reading to the amplitude accuracy for input from 100% of full scale to 110% of full scale.
For the CT6875A-1, add the following for frequencies of
1 kHz < f \leq 1 MHz (the frequency band is 1.5 MHz ± 3 dB):
Amplitude accuracy: $\pm(0.005 \times f \text{ kHz})\%$ of reading, Phase accuracy: $\pm(0.015 \times f \text{ kHz})^\circ$

Temperature and humidity range for guaranteed accuracy	0°C to 40°C (32°F to 104°F), 80% RH or less	
Effect of temperature	In ranges from -40°C to 0°C (-40°F to 32°F) and 40°C to 85°C (104°F to 185°F) Amplitude sensitivity: ± 20 ppm of reading / °C Offset voltage: ± 1 ppm of full scale / °C	
Common-Mode Rejection Ratio (CMRR)	(effect on output voltage and common mode voltage) 140 dB or greater (50/60 Hz) 120 dB or greater (100 kHz)	
Linearity error	± 5 ppm	
Offset error	± 5 ppm	
Amplitude error	DC: ± 10 ppm	20 kHz to 100 kHz: $\pm 0.5\%$
	10 Hz to 100 Hz: $\pm 0.005\%$	100 kHz to 300 kHz: $\pm 1\%$
	100 Hz to 1 kHz: $\pm 0.02\%$	300 kHz to 1 MHz: $\pm 5\%$
	1 kHz to 20 kHz: $\pm 0.08\%$	

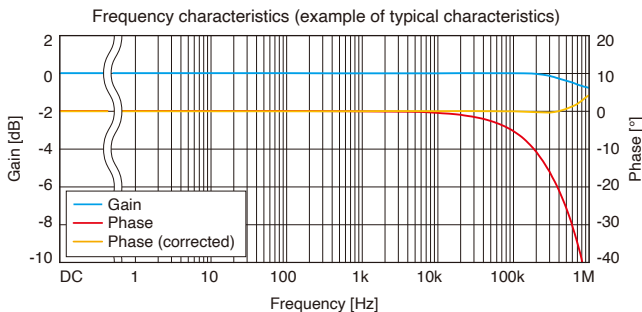
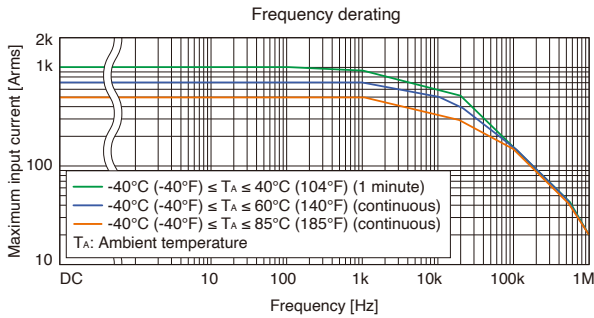

Output voltage	4 mV/A (= 2 V / 500 A)
Operating temperature and humidity range	-40°C to 85°C (-40°F to 185°F), 80% RH or less (no condensation)
Storage temperature and humidity range	-40°C to 85°C (-40°F to 185°F), 80% RH or less (no condensation)
Maximum rated voltage to ground	1000 V CAT III Anticipated transient overvoltage: 8000 V
Standards	Safety: EN61010, EMC: EN61326
Cable length	CT6875A: 3 m (9.84 ft.) CT6875A-1: 10 m (32.81 ft.)
Dimensions	160 mm (6.30 in.) W \times 112 mm (4.41 in.) H \times 50 mm (1.97 in.) D (excluding protruding parts and cables)
Weight	CT6875A: approx. 0.8 kg (28.2 oz.) CT6875A-1: approx. 1.1 kg (38.8 oz.)

CT6904A CT6904A-1



(CT6904A-1: build-to-order product)

Product warranty period: 3 years
Guaranteed accuracy period: 1 year

Rated current	500 A AC/DC
Frequency band	CT6904A: DC to 4 MHz (± 3 dB) CT6904A-1: DC to 2 MHz (± 3 dB)
Diameter of measurable conductors	Max. ϕ 32 mm (1.25 in.)

Accuracy

Frequency	Amplitude \pm (% of reading + % of full scale)	Phase
DC	$\pm 0.025\% \pm 0.007\%$	-
DC < f < 16 Hz	$\pm 0.2\% \pm 0.02\%$	$\pm 0.1^\circ$
16 Hz \leq f < 45 Hz	$\pm 0.1\% \pm 0.02\%$	$\pm 0.1^\circ$
45 Hz \leq f \leq 65 Hz	$\pm 0.02\% \pm 0.007\%$	$\pm 0.08^\circ$
65 Hz < f \leq 850 Hz	$\pm 0.05\% \pm 0.007\%$	$\pm 0.12^\circ$
850 Hz < f \leq 1 kHz	$\pm 0.1\% \pm 0.01\%$	$\pm 0.4^\circ$
1 kHz < f \leq 5 kHz	$\pm 0.4\% \pm 0.02\%$	$\pm 0.4^\circ$
5 kHz < f \leq 10 kHz	$\pm 0.4\% \pm 0.02\%$	$\pm(0.08 \times f \text{ kHz})^\circ$
10 kHz < f \leq 50 kHz	$\pm 1\% \pm 0.02\%$	$\pm(0.08 \times f \text{ kHz})^\circ$
50 kHz < f \leq 100 kHz	$\pm 1\% \pm 0.05\%$	$\pm(0.08 \times f \text{ kHz})^\circ$
100 kHz < f \leq 300 kHz	$\pm 2\% \pm 0.05\%$	$\pm(0.08 \times f \text{ kHz})^\circ$
300 kHz < f \leq 1 MHz	$\pm 5\% \pm 0.05\%$	$\pm(0.08 \times f \text{ kHz})^\circ$

Combined accuracy with HIOKI power analyzer PW8001 and PW6001 is specified (DC, 45 Hz \leq f \leq 65 Hz). For details of combined accuracy, refer to the instruction manual.
Amplitude accuracy and phase accuracy: defined 110% of full scale or less, or within the derating curve (continuous input at an ambient temperature of 50°C); DC < f < 10 Hz is the value by design.
Add $\pm 0.01\%$ of reading to the amplitude accuracy for input from 100% of full scale to 110% of full scale.
For the CT6904A-1, add the following for frequencies of
50 kHz < f \leq 1 MHz (the frequency band is 2 MHz ± 3 dB):
Amplitude accuracy: $\pm(0.015 \times f)\%$ of reading

Temperature and humidity range for guaranteed accuracy	23°C $\pm 5^\circ$ C (73°F $\pm 9^\circ$ F), 80% RH or less
Effect of temperature	In ranges from -10°C to 18°C (14°F to 64.4°F) or 28°C to 50°C (82.4°F to 122°F) Amplitude sensitivity: ± 20 ppm of of reading / °C Offset voltage: ± 1 ppm of full scale / °C Phase: $\pm 0.01^\circ/\text{°C}$
Common-Mode Rejection Ratio (CMRR)	(effect on output voltage and common mode voltage) 140 dB or greater (50/60 Hz) 120 dB or greater (100 kHz)
Linearity error	± 5 ppm
Offset error	± 10 ppm

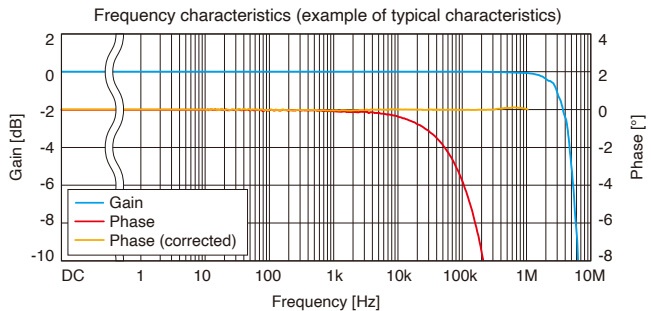
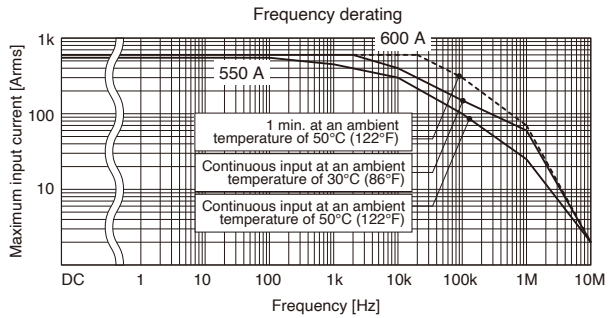

Output voltage	4 mV/A (= 2 V / 500 A)
Operating temperature and humidity range	-10°C to 50°C (-14°F to 122°F), 80% RH or less (no condensation)
Storage temperature and humidity range	-20°C to 60°C (-4°F to 140°F), 80% RH or less (no condensation)
Maximum rated voltage to ground	1000 V CAT III Anticipated transient overvoltage: 8000 V
Standards	Safety: EN61010, EMC: EN61326
Cable length	CT6904A: 3 m (9.84 ft.) (including relay box) CT6904A-1: 10 m (32.81 ft.) (including relay box)
Dimensions	139 mm (5.47 in.) W \times 120 mm (4.72 in.) H \times 52 mm (2.05 in.) D (excluding protrusions and cables)
Weight	CT6904A: approx. 1.05 kg (37.0 oz.) CT6904A-1: approx. 1.35 kg (47.6 oz.)

CT6904A-2 CT6904A-3

(Build-to-order product)



Product warranty period: 3 years
Guaranteed accuracy period: 1 year

Rated current	800 AAC/DC
Frequency band	CT6904A-2: DC to 4 MHz (±3 dB) CT6904A-3: DC to 2 MHz (±3 dB)
Diameter of measurable conductors	Max. φ 32 mm (1.25 in.)

Accuracy

Frequency	Amplitude ±(% of reading + % of full scale)	Phase
DC	±0.030% ±0.009%	-
DC < f < 16 Hz	±0.2% ±0.025%	±0.1°
16 Hz ≤ f < 45 Hz	±0.1% ±0.025%	±0.1°
45 Hz ≤ f ≤ 65 Hz	±0.025% ±0.009%	±0.08°
65 Hz < f ≤ 850 Hz	±0.05% ±0.009%	±0.12°
850 Hz < f ≤ 1 kHz	±0.1% ±0.013%	±0.4°
1 kHz < f ≤ 5 kHz	±0.4% ±0.025%	±0.4°
5 kHz < f ≤ 10 kHz	±0.4% ±0.025%	±(0.08 × f kHz)°
10 kHz < f ≤ 50 kHz	±1% ±0.025%	±(0.08 × f kHz)°
50 kHz < f ≤ 100 kHz	±1% ±0.063%	±(0.08 × f kHz)°
100 kHz < f ≤ 300 kHz	±2% ±0.063%	±(0.08 × f kHz)°
300 kHz < f ≤ 1 MHz	±5% ±0.063%	±(0.08 × f kHz)°

Combined accuracy with HIOKI power analyzer PW8001 and PW6001 is specified (DC, 45 Hz ≤ f ≤ 65 Hz). For details of combined accuracy, refer to the instruction manual.
Amplitude accuracy and phase accuracy are specified by the following conditions:
· Rated value or less
· At 100Hz or more and within the range of "Continuous input at an ambient temperature of 50°C (122°F)" described in the frequency derating graph below
· For the CT6904A-3, add the following for frequencies of 50 kHz < f ≤ 1 MHz (frequency band is 2 MHz ±3):
Amplitude accuracy: ±(0.015 × f)% of reading

Temperature and humidity range for guaranteed accuracy	23°C ±5°C (73°F ±9°F), 80% RH or less
Effect of temperature	In ranges from -10°C to 18°C (14°F to 64.4°F) or 28°C to 50°C (82.4°F to 122°F) Amplitude sensitivity: ± 50 ppm of reading / °C Offset voltage: ±5 ppm of full scale / °C Phase: ±0.01° / °C
Common-Mode Rejection Ratio (CMRR)	(effect on output voltage and common mode voltage) 140 dB or greater (50/60 Hz) 120 dB or greater (100 kHz)
Linearity error	±12.5 ppm
Offset error	±10 ppm

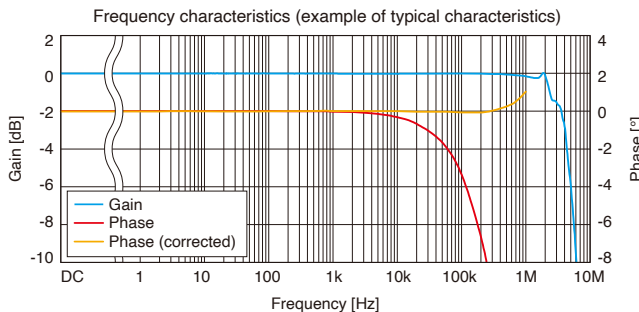
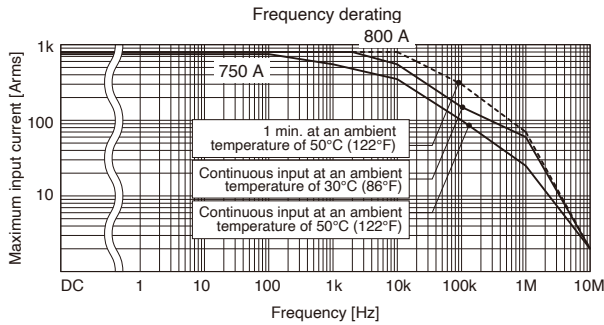

Output voltage	2 mV/A (= 2 V / 1000 A)
Operating temperature and humidity range	-10°C to 50°C (-14°F to 122°F), 80% RH or less (no condensation)
Storage temperature and humidity range	-20°C to 60°C (-4°F to 140°F), 80% RH or less (no condensation)
Maximum rated voltage to ground	1000 V CAT III Anticipated transient overvoltage: 8000 V
Standards	Safety: EN61010, EMC: EN61326
Cable length	CT6904A-2: 3 m (9.84 ft.) (including relay box) CT6904A-3: 10 m (32.81 ft.) (including relay box)
Dimensions	139 mm (5.47 in.) W × 120 mm (4.72 in.) H × 52 mm (2.05 in.) D (excluding protrusions and cables)
Weight	CT6904A-2: approx. 1.15 kg (40.6 oz.) CT6904A-3: approx. 1.45 kg (51.1 oz.)

CT6876A CT6876A-1



Product warranty period: 3 years
Guaranteed accuracy period: 1 year

Rated current	1000 A AC/DC
Frequency band	CT6876A: DC to 1.5 MHz (±3 dB) CT6876A-1: DC to 1.2 MHz (±3 dB)
Diameter of measurable conductors	Max. φ 36 mm (1.41 in.)

Accuracy

Frequency	Amplitude ±(% of reading + % of full scale)	Phase
DC	±0.04% ±0.008%	-
DC < f < 16 Hz	±0.1% ±0.02%	±0.1°
16 Hz ≤ f < 45 Hz	±0.05% ±0.01%	±0.1°
45 Hz ≤ f ≤ 66 Hz	±0.04% ±0.008%	±0.08°
66 Hz < f ≤ 100 Hz	±0.05% ±0.01%	±0.1°
100 Hz < f ≤ 500 Hz	±0.1% ±0.02%	±0.2°
500 Hz < f ≤ 1 kHz	±0.2% ±0.02%	±0.4°
1 kHz < f ≤ 5 kHz	±0.5% ±0.02%	±0.5°
5 kHz < f ≤ 10 kHz	±0.5% ±0.02%	±(0.1 × f kHz)°
10 kHz < f ≤ 50 kHz	±2% ±0.05%	±(0.1 × f kHz)°
50 kHz < f ≤ 100 kHz	±3% ±0.05%	±(0.1 × f kHz)°
100 kHz < f ≤ 1 MHz	±(0.03 × f kHz)% ±0.05%	±(0.1 × f kHz)°

Combined accuracy with HIOKI power analyzer PW8001, PW6001 and PW3390 is specified (DC, 45 Hz ≤ f ≤ 66 Hz). For details of combined accuracy, refer to the instruction manual.
Amplitude accuracy and phase accuracy: defined 110% of full scale or less within the derating curve;
DC < f < 10 Hz is the value by design
· Add ±0.01% of reading to the amplitude accuracy for input from 100% of full scale to 110% of full scale
· For the CT6876A-1, add the following for frequencies of 1 kHz < f ≤ 1 MHz (the frequency band is 1.2 MHz ±3 dB):
Amplitude accuracy: ±(0.005 × f kHz)% of reading, Phase accuracy: ±(0.015 × f kHz)°

Temperature and humidity range for guaranteed accuracy	0°C to 40°C (32°F to 104°F), 80% RH or less
Effect of temperature	In ranges from -40°C to 0°C (-40°F to 32°F) and 40°C to 85°C (104°F to 185°F) Amplitude sensitivity: ±20 ppm of reading / °C Offset voltage: ±1 ppm of full scale / °C
Common-Mode Rejection Ratio (CMRR)	(effect on output voltage and common mode voltage) 140 dB or greater (50/60 Hz) 120 dB or greater (100 kHz)
Linearity error	±5 ppm
Offset error	±5 ppm
Amplitude error	DC: ±10 ppm 10 Hz to 100 Hz: ±0.005% 100 Hz to 1 kHz: ±0.03% 1 kHz to 10 kHz: ±0.2% 10 kHz to 100 kHz: ±1% 100 kHz to 300 kHz: ±3% 300 kHz to 1 MHz: ±15%

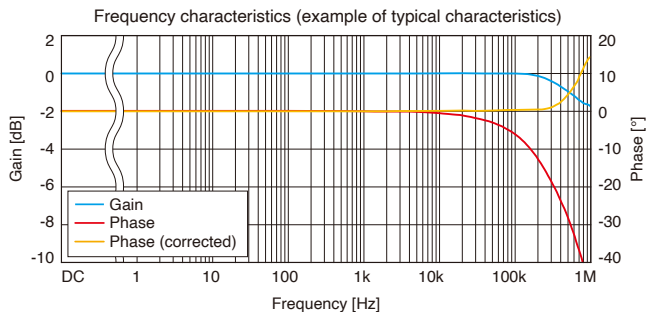
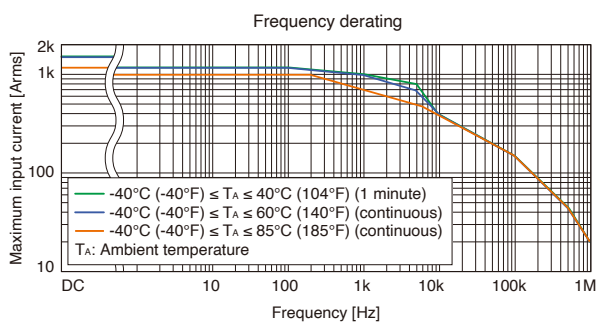

Output voltage	2 mV/A (= 2 V / 1000 A)
Operating temperature and humidity range	-40°C to 85°C (-40°F to 185°F), 80% RH or less (no condensation)
Storage temperature and humidity range	-40°C to 85°C (-40°F to 185°F), 80% RH or less (no condensation)
Maximum rated voltage to ground	1000 V CAT III Anticipated transient overvoltage: 8000 V
Standards	Safety: EN61010, EMC: EN61326
Cable length	CT6876A: 3 m (9.84 ft.) CT6876A-1: 10 m (32.81 ft.)
Dimensions	160 mm (6.30 in.) W × 112 mm (4.41 in.) H × 50 mm (1.97 in.) D (excluding protruding parts and cables)
Weight	CT6876A: approx. 0.95 kg (33.5 oz.) CT6876A-1: approx. 1.25 kg (44.1 oz.)

CT6877A CT6877A-1

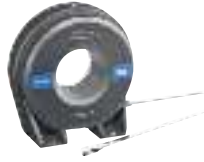

Product warranty period: 3 years
Guaranteed accuracy period: 1 year

Rated current	2000 A AC/DC
Frequency band	DC to 1 MHz
Diameter of measurable conductors	Max. ϕ 80 mm (3.14 in.)

Accuracy

Frequency	Amplitude \pm (% of reading + % of full scale)	Phase
DC	$\pm 0.04\% \pm 0.008\%$	-
DC < f < 16 Hz	$\pm 0.1\% \pm 0.02\%$	$\pm 0.1^\circ$
16 Hz \leq f < 45 Hz	$\pm 0.05\% \pm 0.01\%$	$\pm 0.1^\circ$
45 Hz \leq f \leq 66 Hz	$\pm 0.04\% \pm 0.008\%$	$\pm 0.08^\circ$
66 Hz < f \leq 100 Hz	$\pm 0.05\% \pm 0.01\%$	$\pm 0.1^\circ$
100 Hz < f \leq 500 Hz	$\pm 0.1\% \pm 0.02\%$	$\pm 0.2^\circ$
500 Hz < f \leq 1 kHz	$\pm 0.2\% \pm 0.02\%$	$\pm 0.4^\circ$
1 kHz < f \leq 5 kHz	$\pm 0.5\% \pm 0.02\%$	$\pm (0.3 + 0.1 \times f \text{ kHz})^\circ$
5 kHz < f \leq 10 kHz	$\pm 0.5\% \pm 0.02\%$	$\pm (0.3 + 0.1 \times f \text{ kHz})^\circ$
10 kHz < f \leq 50 kHz	$\pm 1.5\% \pm 0.05\%$	$\pm (0.3 + 0.1 \times f \text{ kHz})^\circ$
50 kHz < f \leq 100 kHz	$\pm 2.5\% \pm 0.05\%$	$\pm (0.3 + 0.1 \times f \text{ kHz})^\circ$
100 kHz < f \leq 700 kHz	$\pm (0.025 \times f)\% \pm 0.05\%$	$\pm (0.3 + 0.1 \times f \text{ kHz})^\circ$

Combined accuracy with HIOKI power analyzer PW8001, PW6001 and PW3390 is specified (DC, 45 Hz \leq f \leq 66 Hz). For details of combined accuracy, refer to the instruction manual.
 * Amplitude accuracy and phase accuracy: defined 110% of full scale or less, or within the derating curve, DC < f < 10 Hz is the value by design.
 * Add $\pm 0.01\%$ of reading to the amplitude accuracy for input from 100% of full scale to 110% of full scale.
 * For the CT6877A-1, add the following for frequencies of 1 kHz < f \leq 700 kHz:
 Amplitude accuracy: $\pm(0.005 \times f)\%$ of reading, Phase accuracy: $\pm(0.015 \times f)^\circ$

Temperature and humidity range for guaranteed accuracy	0°C to 40°C (32°F to 104°F), 80% RH or less	
Effect of temperature	In ranges from -40°C to 0°C (-40°F to 32°F) and 40°C to 85°C (104°F to 185°F) Amplitude sensitivity: ± 15 ppm of reading / °C Offset voltage: ± 0.5 ppm of full scale / °C	
Common-Mode Rejection Ratio (CMRR)	(effect on output voltage and common mode voltage) 140 dB or greater (50/60 Hz) 120 dB or greater (100 kHz)	
Linearity error	± 10 ppm	
Offset error	± 5 ppm	
Amplitude error	DC: ± 15 ppm 10 Hz to 100 Hz: $\pm 0.01\%$ 100 Hz to 1 kHz: $\pm 0.04\%$ 1 kHz to 10 kHz: $\pm 0.25\%$	10 kHz to 100 kHz: $\pm 1\%$ 100 kHz to 300 kHz: $\pm 2\%$ 300 kHz to 700 kHz: $\pm 10\%$

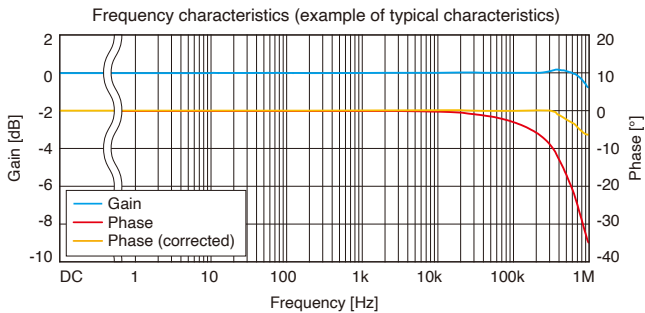
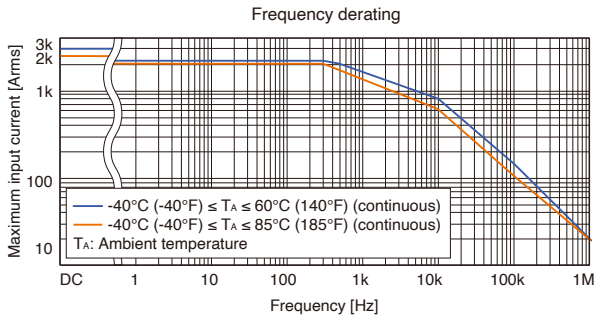

Output voltage	1 mV/A (= 2 V / 2000 A)
Operating temperature and humidity range	-40°C to 85°C (-40°F to 185°F), 80% RH or less (no condensation)
Storage temperature and humidity range	-40°C to 85°C (-40°F to 185°F), 80% RH or less (no condensation)
Maximum rated voltage to ground	1000 V CAT III Anticipated transient overvoltage: 8000 V
Standards	Safety: EN61010, EMC: EN61326
Cable length	CT6877A: 3 m (9.84 ft.) CT6877A-1: 10 m (32.81 ft.)
Dimensions	229 mm (9.02 in.) W × 232 mm (9.13 in.) H × 112 mm (4.41 in.) D (excluding protruding parts and cables)
Weight	CT6877A: approx. 5 kg (176.4 oz.) CT6877A-1: approx. 5.3 kg (187.0 oz.)

PW9100A-3 PW9100A-4



Product warranty period: 3 years
Guaranteed accuracy period: 1 year

Rated current	50 A AC/DC
Frequency band	DC to 3.5 MHz
Input and measurement method	Isolated input, DCCT* input
Measurement terminals	Terminal block M6 screws

*Direct Connection Current Transducer

Accuracy

Frequency	Amplitude \pm (% of reading + % of full scale)	Phase
DC	$\pm 0.02\% \pm 0.007\%$	-
DC < f < 30 Hz	$\pm 0.1\% \pm 0.02\%$	$\pm 0.3^\circ$
30 Hz \leq f < 45 Hz	$\pm 0.1\% \pm 0.02\%$	$\pm 0.1^\circ$
45 Hz \leq f \leq 65 Hz	$\pm 0.02\% \pm 0.005\%$	$\pm 0.1^\circ$
65 Hz < f \leq 500 Hz	$\pm 0.1\% \pm 0.01\%$	$\pm 0.12^\circ$
500 Hz < f \leq 1 kHz	$\pm 0.1\% \pm 0.01\%$	$\pm 0.5^\circ$
1 kHz < f \leq 5 kHz	$\pm 0.5\% \pm 0.02\%$	$\pm 0.5^\circ$
5 kHz < f \leq 20 kHz	$\pm 1\% \pm 0.02\%$	$\pm 1^\circ$
20 kHz < f \leq 50 kHz	$\pm 1\% \pm 0.02\%$	$\pm (0.05 \times f \text{ kHz})^\circ$
50 kHz < f \leq 100 kHz	$\pm 2\% \pm 0.05\%$	$\pm (0.06 \times f \text{ kHz})^\circ$
100 kHz < f \leq 300 kHz	$\pm 5\% \pm 0.05\%$	$\pm (0.06 \times f \text{ kHz})^\circ$
300 kHz < f \leq 700 kHz	$\pm 5\% \pm 0.05\%$	$\pm (0.07 \times f \text{ kHz})^\circ$
700 kHz < f \leq 1 MHz	$\pm 10\% \pm 0.05\%$	$\pm (0.07 \times f \text{ kHz})^\circ$

Combined accuracy with HIOKI power analyzer PW8001, PW6001 and PW3390 is specified (DC, 45 Hz \leq f \leq 65 Hz). For details of combined accuracy, refer to the instruction manual.
 * Amplitude accuracy and phase accuracy: defined within the accuracy guarantee range shown in the derating figure below; DC < f < 10 Hz is the value by design.
 * Add $\pm 0.01\%$ of reading to the amplitude accuracy for input from 100% of full scale to 110% of full scale

Temperature and humidity range for guaranteed accuracy	23°C $\pm 5^\circ$ C (73°F $\pm 9^\circ$ F), 80% RH or less
Effect of temperature	In ranges from 0°C to 18°C (32°F to 64°F) and 28°C to 40°C (82°F to 104°F) Amplitude sensitivity: ± 20 ppm of reading / °C Offset voltage: ± 1 ppm of full scale / °C Phase: $\pm 0.01^\circ$ / °C
Common-Mode Rejection Ratio (CMRR)	(effect on output voltage and common mode voltage) 120 dB or greater (50/60 Hz, 100 kHz)

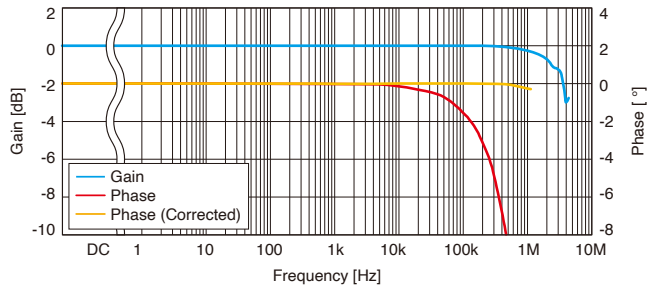
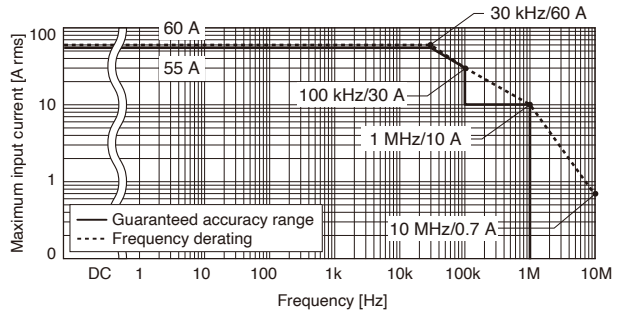

Output voltage	40 mV/A (= 2 V / 50 A)
Operating temperature and humidity range	0°C to 40°C (32°F to 104°F), 80% RH or less (no condensation)
Storage temperature and humidity range	-10°C to 50°C (14°F to 122°F), 80% RH or less (no condensation)
Maximum rated voltage to ground	600 V CAT III, 1000 V CAT II Anticipated transient overvoltage: 6000 V
Standards	Safety: EN 61010, EMC: EN 61326 Class A
Cable length	0.8 m (2.62 ft.)
Dimensions	430 mm (16.9 in.) W × 88 mm (3.46 in.) H × 260 mm (10.23 in.) D
Weight	PW9100A-3: approx. 3.7 kg (130.5 oz.) PW9100A-4: approx. 4.3 kg (151.7 oz.)

CT6841A



Product warranty period: 3 years
Guaranteed accuracy period: 1 year

Rated current	20 A AC/DC
Frequency band	DC to 2 MHz
Diameter of measurable conductors	Max. φ 20 mm (0.79 in.)

Accuracy

Frequency	Amplitude ±(% of reading + % of full scale)	Phase
DC	±0.2% ±0.05%*	-
DC < f ≤ 100 Hz	±0.2% ±0.01%	±0.1°
100 Hz < f ≤ 500 Hz	±0.3% ±0.02%	±0.2°
500 Hz < f ≤ 1 kHz	±0.5% ±0.02%	±0.5°
1 kHz < f ≤ 5 kHz	±1.0% ±0.02%	±1.0°
5 kHz < f ≤ 10 kHz	±1.5% ±0.02%	±1.5°
10 kHz < f ≤ 50 kHz	±2.0% ±0.02%	±(0.5 + 0.1 × f kHz)°
50 kHz < f ≤ 100 kHz	±5.0% ±0.05%	±(0.5 + 0.1 × f kHz)°
100 kHz < f ≤ 300 kHz	±10% ±0.05%	±(0.5 + 0.1 × f kHz)°
300 kHz < f ≤ 500 kHz	±15% ±0.05%	±(0.5 + 0.1 × f kHz)°
500 kHz < f < 1 MHz	±30% ±0.05%	±(0.5 + 0.1 × f kHz)°

Combined accuracy with HIOKI power analyzer PW8001, PW6001 and PW3390 is specified (DC, 45 Hz ≤ f ≤ 66 Hz). For details of combined accuracy, refer to the instruction manual.
*DC accuracy after adjusting the offset voltage to ±0.5 mV or less.

- The values above are when the input is a sine wave or DC, the measurement instrument's input resistance is 1 MΩ ± 10%, voltage to ground 0 V, no external magnetic fields and the conductor is in the center of the sensor opening.
- Amplitude accuracy and phase accuracy are defined 110% of full scale or less and within the derating curve. DC < f < 10 Hz is a design value.
- Add ±0.03% of reading to the amplitude accuracy for input from 100% of full scale to 110% of full scale.

Temperature and humidity range for guaranteed accuracy	0°C to 40°C (32°F to 104°F), 80% RH or less
Effect of temperature	In ranges from -40°C to 0°C (-40°F to 32°F) and 40°C to 85°C (104°F to 185°F) Amplitude sensitivity: ±0.01% of reading / °C Offset voltage: ±0.005% of full scale / °C
Common-Mode Rejection Ratio (CMRR)	(effect on output voltage and common mode voltage) 140 dB or greater (DC to 1 kHz) 125 dB or greater (1 kHz to 10 kHz) 100 dB or greater (10 kHz to 100 kHz) 80 dB or greater (100 kHz to 1 MHz)
Linearity error	±20 ppm

Frequency derating

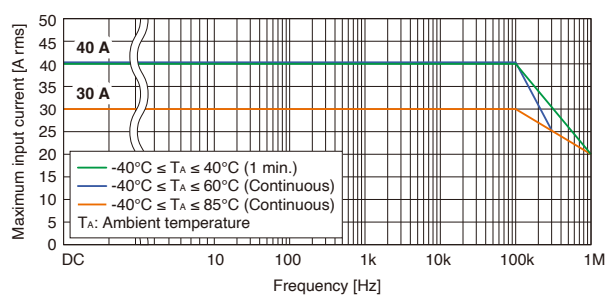

Frequency characteristics (example of typical characteristics)

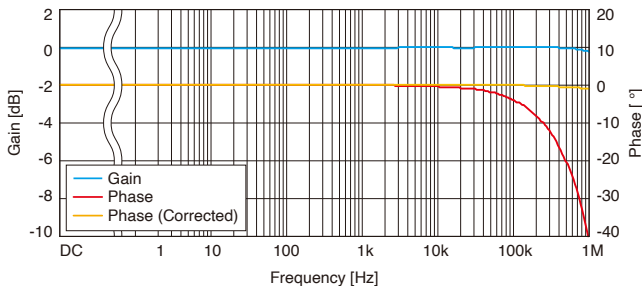

Output voltage	100 mV/A (= 2 V / 20 A)
Measurable conductors	Insulated conductor
Operating temperature and humidity range	-40°C to 85°C (-40°F to 185°F), 80% RH or less (no condensation)
Storage temperature and humidity range	-40°C to 85°C (-40°F to 185°F), 80% RH or less (no condensation)
Withstand voltage	4260 V AC Withstand test current of 1 mA, 50/60 Hz, 1 min., between jaws and cable output terminal
Standards	Safety: EN 61010, EMC: EN 61326
Cable length	3 m (9.84 ft.)
Dimensions	153 mm (6.02 in.) W × 67 mm (2.64 in.) H × 25 mm (0.98 in.) D (excluding protruding parts and cables)
Weight	Approx. 370 g (13.1 oz.)

CT6843A



Product warranty period: 3 years
Guaranteed accuracy period: 1 year

Rated current	200 A AC/DC
Frequency band	DC to 700 kHz
Diameter of measurable conductors	Max. φ 20 mm (0.79 in.)

Accuracy

Frequency	Amplitude ±(% of reading + % of full scale)	Phase
DC	±0.2% ±0.02%*	-
DC < f ≤ 100 Hz	±0.2% ±0.01%	±0.1°
100 Hz < f ≤ 500 Hz	±0.3% ±0.02%	±0.2°
500 Hz < f ≤ 1 kHz	±0.5% ±0.02%	±0.5°
1 kHz < f ≤ 5 kHz	±1.0% ±0.02%	±1.0°
5 kHz < f ≤ 10 kHz	±1.5% ±0.02%	±1.5°
10 kHz < f ≤ 50 kHz	±5.0% ±0.02%	±(0.5 + 0.1 × f kHz)°
50 kHz < f ≤ 100 kHz	±15% ±0.05%	±(0.5 + 0.1 × f kHz)°
100 kHz < f ≤ 300 kHz	±15% ±0.05%	±(0.5 + 0.1 × f kHz)°
300 kHz < f ≤ 500 kHz	±30% ±0.05%	±(0.5 + 0.1 × f kHz)°

Combined accuracy with HIOKI power analyzer PW8001, PW6001 and PW3390 is specified (DC, 45 Hz ≤ f ≤ 66 Hz). For details of combined accuracy, refer to the instruction manual.
*DC accuracy after adjusting the offset voltage to ±0.2 mV or less.

- The values above are when the input is a sine wave or DC, the measurement instrument's input resistance is 1 MΩ ± 10%, voltage to ground 0 V, no external magnetic fields and the conductor is in the center of the sensor opening.
- Amplitude accuracy and phase accuracy are defined 110% of full scale or less and within the derating curve. DC < f < 10 Hz is a design value.
- Add ±0.03% of reading to the amplitude accuracy for input from 100% of full scale to 110% of full scale.

Temperature and humidity range for guaranteed accuracy	0°C to 40°C (32°F to 104°F), 80% RH or less
Effect of temperature	In ranges from -40°C to 0°C (-40°F to 32°F) and 40°C to 85°C (104°F to 185°F) Amplitude sensitivity: ±0.01% of reading / °C Offset voltage: ±0.005% of full scale / °C
Common-Mode Rejection Ratio (CMRR)	(effect on output voltage and common mode voltage) 150 dB or greater (DC to 1 kHz) 135 dB or greater (1 kHz to 10 kHz) 115 dB or greater (10 kHz to 100 kHz) 95 dB or greater (100 kHz to 500 kHz)
Linearity error	±20 ppm

Frequency derating

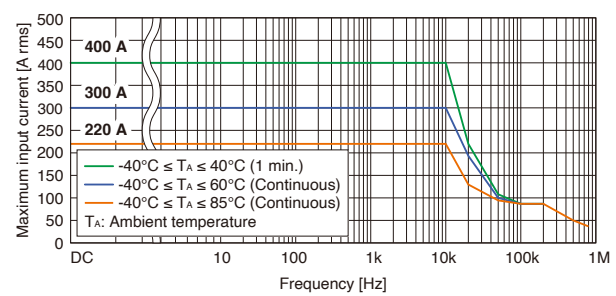

Frequency characteristics (example of typical characteristics)

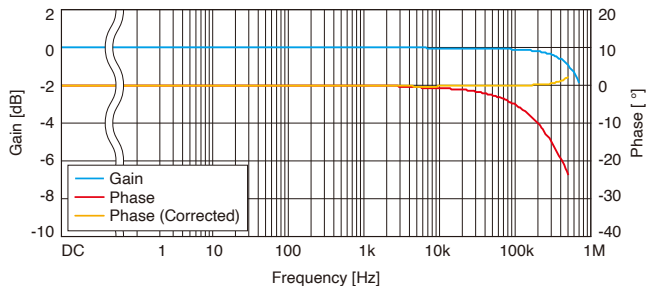

Output voltage	10 mV/A (= 2 V / 200 A)
Measurable conductors	Insulated conductor
Operating temperature and humidity range	-40°C to 85°C (-40°F to 185°F), 80% RH or less (no condensation)
Storage temperature and humidity range	-40°C to 85°C (-40°F to 185°F), 80% RH or less (no condensation)
Withstand voltage	4260 V AC Withstand test current of 1 mA, 50/60 Hz, 1 min., between jaws and cable output terminal
Standards	Safety: EN 61010, EMC: EN 61326
Cable length	3 m (9.84 ft.)
Dimensions	153 mm (6.02 in.) W × 67 mm (2.64 in.) H × 25 mm (0.98 in.) D (excluding protruding parts and cables)
Weight	Approx. 380 g (13.4 oz.)

CT6844A



Product warranty period: 3 years
Guaranteed accuracy period: 1 year

Rated current	500 A AC/DC
Frequency band	DC to 500 kHz
Diameter of measurable conductors	Max. ϕ 20 mm (0.79 in.)

Accuracy

Frequency	Amplitude \pm (% of reading + % of full scale)	Phase
DC	$\pm 0.2\% \pm 0.02\%^*$	-
DC < f \leq 100 Hz	$\pm 0.2\% \pm 0.01\%$	$\pm 0.1^\circ$
100 Hz < f \leq 500 Hz	$\pm 0.3\% \pm 0.02\%$	$\pm 0.2^\circ$
500 Hz < f \leq 1 kHz	$\pm 0.5\% \pm 0.02\%$	$\pm 0.5^\circ$
1 kHz < f \leq 5 kHz	$\pm 1.0\% \pm 0.02\%$	$\pm 1.0^\circ$
5 kHz < f \leq 10 kHz	$\pm 1.5\% \pm 0.02\%$	$\pm 1.5^\circ$
10 kHz < f \leq 50 kHz	$\pm 5.0\% \pm 0.02\%$	$\pm (0.15 \times f \text{ kHz})^\circ$
50 kHz < f \leq 100 kHz	$\pm 15\% \pm 0.05\%$	$\pm (0.15 \times f \text{ kHz})^\circ$
100 kHz < f \leq 300 kHz	$\pm 30\% \pm 0.05\%$	$\pm (0.15 \times f \text{ kHz})^\circ$

Combined accuracy with HIOKI power analyzer PW8001, PW6001 and PW3390 is specified (DC, 45 Hz \leq f \leq 66 Hz). For details of combined accuracy, refer to the instruction manual.
*DC accuracy after adjusting the offset voltage to ± 0.2 mV or less.

- The values above are when the input is a sine wave or DC, the measurement instrument's input resistance is $1 \text{ M}\Omega \pm 10\%$, voltage to ground 0 V, no external magnetic fields and the conductor is in the center of the sensor opening.
- Amplitude accuracy and phase accuracy are defined 110% of full scale or less and within the derating curve. DC < f < 10 Hz is a design value.

Temperature and humidity range for guaranteed accuracy	0°C to 40°C (32°F to 104°F), 80% RH or less
Effect of temperature	In ranges from -40°C to 0°C (-40°F to 32°F) and 40°C to 85°C (104°F to 185°F) Amplitude sensitivity: $\pm 0.01\%$ of reading / °C Offset voltage: $\pm 0.005\%$ of full scale / °C
Common-Mode Rejection Ratio (CMRR)	(effect on output voltage and common mode voltage) 150 dB or greater (DC to 1 kHz) 135 dB or greater (1 kHz to 10 kHz) 120 dB or greater (10 kHz to 100 kHz) 100 dB or greater (100 kHz to 300 kHz)
Linearity error	± 20 ppm

Frequency derating

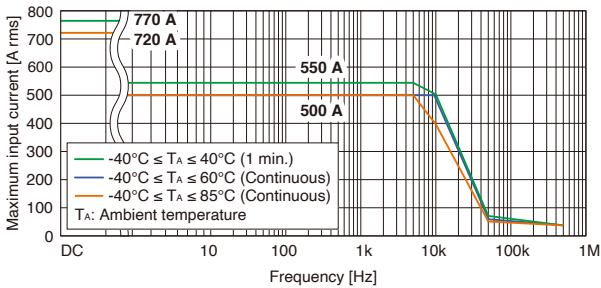

Frequency characteristics (example of typical characteristics)

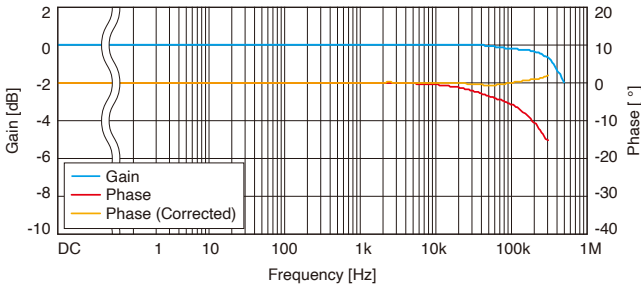

Output voltage	4 mV/A (= 2 V / 500 A)
Measurable conductors	Insulated conductor
Operating temperature and humidity range	-40°C to 85°C (-40°F to 185°F), 80% RH or less (no condensation)
Storage temperature and humidity range	-40°C to 85°C (-40°F to 185°F), 80% RH or less (no condensation)
Withstand voltage	4260 V AC Withstand test current of 1 mA, 50/60 Hz, 1 min., between jaws and cable output terminal
Standards	Safety: EN 61010, EMC: EN 61326
Cable length	3 m (9.84 ft.)
Dimensions	153 mm (6.02 in.) W x 67 mm (2.64 in.) H x 25 mm (0.98 in.) D (excluding protruding parts and cables)
Weight	Approx. 400 g (14.1 oz.)

CT6845A



Product warranty period: 3 years
Guaranteed accuracy period: 1 year

Rated current	500 A AC/DC
Frequency band	DC to 200 kHz
Diameter of measurable conductors	Max. ϕ 50 mm (1.97 in.)

Accuracy

Frequency	Amplitude \pm (% of reading + % of full scale)	Phase
DC	$\pm 0.2\% \pm 0.02\%^*$	-
DC < f \leq 100 Hz	$\pm 0.2\% \pm 0.01\%$	$\pm 0.1^\circ$
100 Hz < f \leq 500 Hz	$\pm 0.3\% \pm 0.02\%$	$\pm 0.2^\circ$
500 Hz < f \leq 1 kHz	$\pm 0.5\% \pm 0.02\%$	$\pm 0.5^\circ$
1 kHz < f \leq 5 kHz	$\pm 1.0\% \pm 0.02\%$	$\pm (0.5 \times f \text{ kHz})^\circ$
5 kHz < f \leq 10 kHz	$\pm 1.5\% \pm 0.02\%$	$\pm (0.5 \times f \text{ kHz})^\circ$
10 kHz < f \leq 20 kHz	$\pm 5.0\% \pm 0.02\%$	$\pm (0.5 \times f \text{ kHz})^\circ$
20 kHz < f \leq 50 kHz	$\pm 10\% \pm 0.05\%$	$\pm (0.5 \times f \text{ kHz})^\circ$
50 kHz < f \leq 100 kHz	$\pm 30\% \pm 0.05\%$	$\pm (0.5 \times f \text{ kHz})^\circ$

Combined accuracy with HIOKI power analyzer PW8001, PW6001 and PW3390 is specified (DC, 45 Hz \leq f \leq 66 Hz). For details of combined accuracy, refer to the instruction manual.
*DC accuracy after adjusting the offset voltage to ± 0.2 mV or less.

- The values above are when the input is a sine wave or DC, the measurement instrument's input resistance is $1 \text{ M}\Omega \pm 10\%$, voltage to ground 0 V, no external magnetic fields and the conductor is in the center of the sensor opening.
- Amplitude accuracy and phase accuracy are defined 110% of full scale or less and within the derating curve. DC < f < 10 Hz is a design value.
- Add $\pm 0.03\%$ of reading to the amplitude accuracy for input from 100% of full scale to 110% of full scale.

Temperature and humidity range for guaranteed accuracy	0°C to 40°C (32°F to 104°F), 80% RH or less
Effect of temperature	In ranges from -40°C to 0°C (-40°F to 32°F) and 40°C to 85°C (104°F to 185°F) Amplitude sensitivity: $\pm 0.01\%$ of reading / °C Offset voltage: $\pm 0.005\%$ of full scale / °C
Common-Mode Rejection Ratio (CMRR)	(effect on output voltage and common mode voltage) 150 dB or greater (DC to 1 kHz) 130 dB or greater (1 kHz to 10 kHz) 100 dB or greater (10 kHz to 100 kHz)
Linearity error	± 20 ppm

Frequency derating

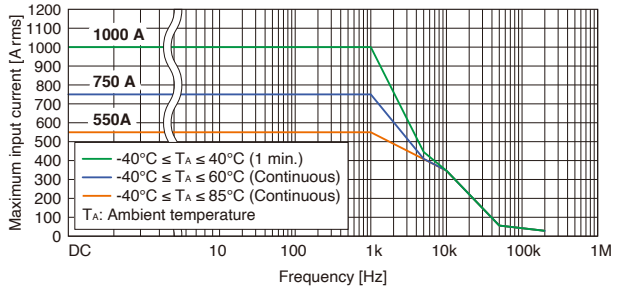

Frequency characteristics (example of typical characteristics)

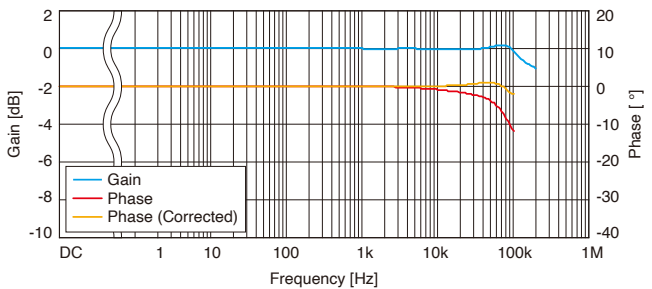

Output voltage	4 mV/A (= 2 V / 500 A)
Measurable conductors	Insulated conductor
Operating temperature and humidity range	-40°C to 85°C (-40°F to 185°F), 80% RH or less (no condensation)
Storage temperature and humidity range	-40°C to 85°C (-40°F to 185°F), 80% RH or less (no condensation)
Withstand voltage	4260 V AC Withstand test current of 1 mA, 50/60 Hz, 1 min., between jaws and cable output terminal
Standards	Safety: EN 61010, EMC: EN 61326
Cable length	3 m (9.84 ft.)
Dimensions	238 mm (9.37 in.) W x 116 mm (4.57 in.) H x 35 mm (1.38 in.) D (excluding protruding parts and cables)
Weight	Approx. 860 g (30.3 oz.)

CT6846A



Product warranty period: 3 years
Guaranteed accuracy period: 1 year

Rated current	1000 A AC/DC
Frequency band	DC to 100 kHz
Diameter of measurable conductors	Max. ϕ 50 mm (1.97 in.)

Accuracy

Frequency	Amplitude \pm (% of reading + % of full scale)	Phase
DC	$\pm 0.2\% \pm 0.02\%^*$	-
DC < f \leq 100 Hz	$\pm 0.2\% \pm 0.01\%$	$\pm 0.1^\circ$
100 Hz < f \leq 500 Hz	$\pm 0.5\% \pm 0.02\%$	$\pm 0.2^\circ$
500 Hz < f \leq 1 kHz	$\pm 1.0\% \pm 0.02\%$	$\pm 0.5^\circ$
1 kHz < f \leq 5 kHz	$\pm 2.0\% \pm 0.02\%$	$\pm (0.7 \times f \text{ kHz})^\circ$
5 kHz < f \leq 10 kHz	$\pm 5.0\% \pm 0.02\%$	$\pm (0.7 \times f \text{ kHz})^\circ$
10 kHz < f \leq 50 kHz	$\pm 30\% \pm 0.02\%$	$\pm (0.7 \times f \text{ kHz})^\circ$

Combined accuracy with HIOKI power analyzer PW8001, PW6001 and PW3390 is specified (DC, 45 Hz \leq f \leq 66 Hz). For details of combined accuracy, refer to the instruction manual.
*DC accuracy after adjusting the offset voltage to ± 0.2 mV or less.

- The values above are when the input is a sine wave or DC, the measurement instrument's input resistance is 1 M Ω \pm 10%, voltage to ground 0 V, no external magnetic fields and the conductor is in the center of the sensor opening.
- Amplitude accuracy and phase accuracy are defined 110% of full scale or less and within the derating curve. DC < f < 10 Hz is a design value.
- Add $\pm 0.03\%$ of reading to the amplitude accuracy for input from 100% of full scale to 110% of full scale.

Temperature and humidity range for guaranteed accuracy	0°C to 40°C (32°F to 104°F), 80% RH or less
Effect of temperature	In ranges from -40°C to 0°C (-40°F to 32°F) and 40°C to 85°C (104°F to 185°F) Amplitude sensitivity: $\pm 0.01\%$ of reading / °C Offset voltage: $\pm 0.005\%$ of full scale / °C
Common-Mode Rejection Ratio (CMRR)	(effect on output voltage and common mode voltage) 150 dB or greater (DC to 1 kHz) 130 dB or greater (1 kHz to 10 kHz) 100 dB or greater (10 kHz to 50 kHz)
Linearity error	± 20 ppm

Frequency derating

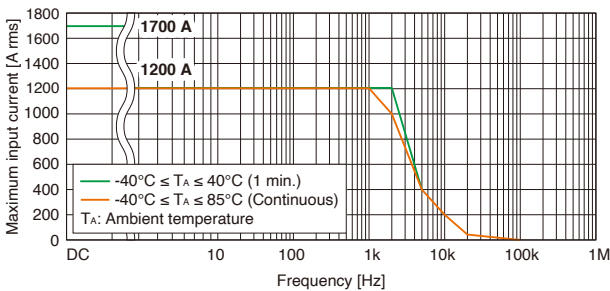

Frequency characteristics (example of typical characteristics)

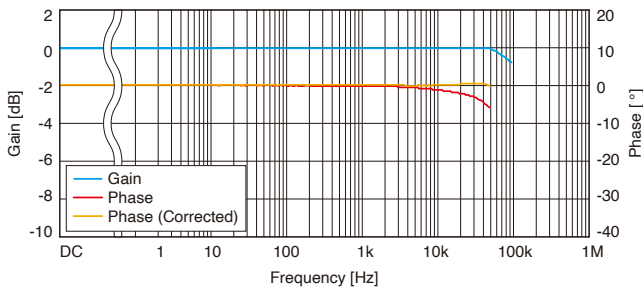

Output voltage	2 mV/A (= 2 V / 1000 A)
Measurable conductors	Insulated conductor
Operating temperature and humidity range	-40°C to 85°C (-40°F to 185°F), 80% RH or less (no condensation)
Storage temperature and humidity range	-40°C to 85°C (-40°F to 185°F), 80% RH or less (no condensation)
Withstand voltage	4260 V AC Withstand test current of 1 mA, 50/60 Hz, 1 min., between jaws and cable output terminal
Standards	Safety: EN 61010, EMC: EN 61326
Cable length	3 m (9.84 ft.)
Dimensions	238 mm (9.37 in.) W \times 116 mm (4.57 in.) H \times 35 mm (1.38 in.) D (excluding protruding parts and cables)
Weight	Approx. 990 g (34.9 oz.)

9272-05



Product warranty period: 3 years
Guaranteed accuracy period: 1 year

Rated current	20 A AC, 200 A AC (2 ranges)
Frequency band	1 Hz to 100 kHz
Diameter of measurable conductors	ϕ 46 mm or less

Accuracy

Frequency	Amplitude \pm (% of reading + % of full scale)	Phase
1 Hz \leq f < 5 Hz	$\pm 2.0\% \pm 0.10\%$	-
5 Hz \leq f < 10 Hz	$\pm 1.0\% \pm 0.05\%$	$\pm 1.0^\circ$
10 Hz \leq f < 45 Hz	$\pm 0.5\% \pm 0.02\%$	$\pm 0.5^\circ$
45 Hz \leq f \leq 66 Hz	$\pm 0.3\% \pm 0.01\%$	$\pm 0.2^\circ$
66 Hz < f \leq 500 Hz	$\pm 0.5\% \pm 0.02\%$	$\pm 0.5^\circ$
500 Hz < f \leq 1 kHz	$\pm 0.5\% \pm 0.02\%$	$\pm 1.0^\circ$
1 kHz < f \leq 5 kHz	$\pm 1.0\% \pm 0.05\%$	$\pm 2.0^\circ$
5 kHz < f \leq 10 kHz	$\pm 2.5\% \pm 0.10\%$	$\pm 3.0^\circ$
10 kHz < f \leq 20 kHz	$\pm 5\% \pm 0.1\%$	$\pm 5.0^\circ$
20 kHz < f \leq 50 kHz	$\pm 5\% \pm 0.1\%$	$\pm 15.0^\circ$
50 kHz < f \leq 100 kHz	$\pm 30\% \pm 0.1\%$	-

Accuracy is specified by the following conditions:
 • Less than or equal to the rated current of each current range
 • Within derating range of each current range
 The accuracy values above are for within the rated current for each range and inside of derating range. (The values are the values by design: amplitude at under 5 Hz and phase at under 10 Hz)

Temperature and humidity range for guaranteed accuracy	23°C \pm 5°C (73°F \pm 9°F), 80% RH or less
Effect of temperature	Amplitude sensitivity: $\pm 0.03\%$ of reading / °C

Frequency derating

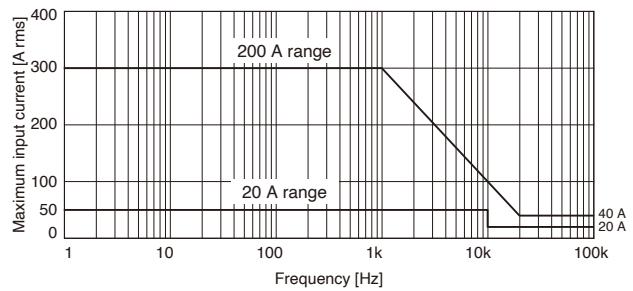

Frequency characteristics (example of typical characteristics)

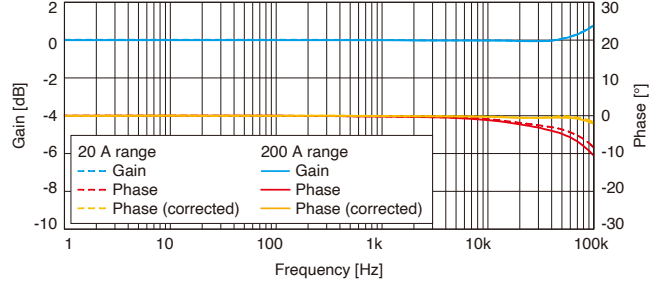

Output voltage	20 A range: 100 mV/A (= 2 V / 20 A) 200 A range: 10 mV/A (= 2 V / 200 A)
Operating temperature and humidity range	0°C to 50°C (32°F to 122°F), 80% RH or less (no condensation)
Storage temperature and humidity range	-10°C to 60°C (14°F to 140°F), 80% RH or less (no condensation)
Maximum rated voltage to ground	600 V AC CAT III (50/60 Hz) Anticipated transient overvoltage: 6000 V
Standards	Safety: EN 61010, EMC: EN 61326 Class A
Cable length	3 m (9.84 ft.)
Dimensions	78 mm (3.07 in) W \times 188 mm (7.40 in) H \times 35 mm (1.38 in) D (excluding protruding parts and cables)
Weight	Approx. 450 g (15.9 oz.)

CT6710

Product warranty period: 1 year
Guaranteed accuracy period: 1 year



Rated current* (3 ranges)	30 Arms, 5 Arms, 0.5 Arms AC/DC
Frequency band	DC to 50 MHz (-3dB)
Diameter of measurable conductors	Max. ϕ 5 mm (0.20 in.) (insulated conductors)

*DC or sine wave signals of 45 to 66 Hz, within maximum peak current for each range

Rise time	7.0 ns or less (10% to 90%)
Output voltage	0.1 V/A (30 A range) 1 V/A (5 A range) 10 V/A (0.5 A range)
Maximum peak current	± 50 A peak* ¹ (30 A range) ± 7.5 A peak (5 A range) ± 0.75 A peak (0.5 A range, ≥ 10 MHz) ± 0.3 A peak (0.5 A range, < 10 MHz)
Noise	75 μ Arms or less* ² (typical: 60 μ Arms)

*1: Maximum 2 sec input; requires cooling time of at least 10 times longer than the time current has been input
*2: Does not apply to devices to which the probe is connected; applicable in the 0.5 A range and when used with 20 MHz bandwidth instrument devices

Accuracy (amplitude)

Range	Accuracy	typical
30 A	$\pm 3.0\%$ of reading ± 1 mV	$\pm 1.0\%$ of reading ± 1 mV (≤ 10 A)
5 A	$\pm 3.0\%$ of reading ± 1 mV	$\pm 1.0\%$ of reading ± 1 mV
0.5 A	$\pm 3.0\%$ of reading ± 10 mV	$\pm 1.0\%$ of reading ± 10 mV

The accuracy above is valid within the following conditions:
Warm-up time: 30 minutes, operating environment of $23^{\circ}\text{C} \pm 5^{\circ}\text{C}$ ($73^{\circ}\text{F} \pm 9^{\circ}\text{F}$) at 80% RH or less, DC or sine wave signals of 45 to 66 Hz, within maximum peak current for each range

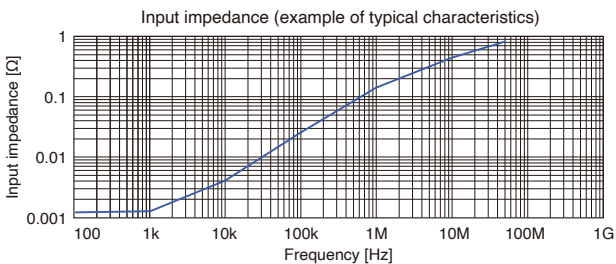
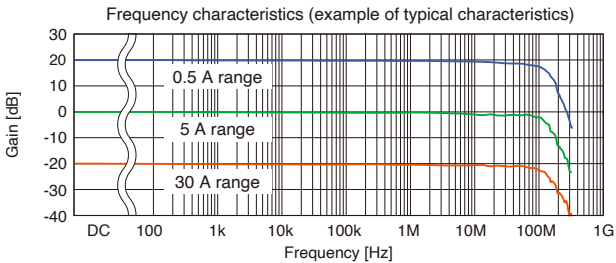
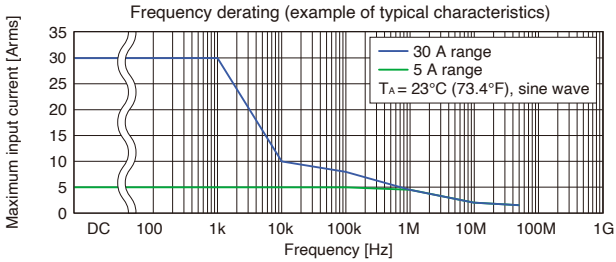

Operating temperature and humidity range	0°C to 40°C (32°F to 104°F), 80% RH or less (no condensation)
Storage temperature and humidity range	-10°C to 50°C (14°F to 122°F), 80% RH or less (no condensation)
Standards	Safety: EN 61010, EMC: EN 61326
Maximum rated power	7.8 VA (continuous maximum input)
Cable length	Sensor/junction box: 1500 mm (59.06 in.) Junction box/termination unit: 150 mm (5.91 in.) Power cord: 1000 mm (39.37 in.)
Dimensions	Sensor: 155 mm (6.10 in.) W x 18 mm (0.71 in.) H x 26 mm (1.02 in.) D Junction box: 45 mm (1.77 in.) W x 120 mm (4.72 in.) H x 25 mm (0.98 in.) D Termination unit: 29 mm (1.14 in.) W x 83 mm (3.27 in.) H x 40 mm (1.57 in.) D (excluding BNC connector or protrusions)
Weight	Approx. 370 g (13.1 oz.)

CT6711

Product warranty period: 1 year
Guaranteed accuracy period: 1 year



Rated current* (3 ranges)	30 Arms, 5 Arms, 0.5 Arms AC/DC
Frequency band	DC to 120 MHz (-3dB)
Diameter of measurable conductors	Max. ϕ 5 mm (0.20 in.) (insulated conductors)

*DC or sine wave signals of 45 to 66 Hz, within maximum peak current for each range

Rise time	2.9 ns or less (10% to 90%)
Output voltage	0.1 V/A (30 A range) 1 V/A (5 A range) 10 V/A (0.5 A range)
Maximum peak current	± 50 A peak* ¹ (30 A range) ± 7.5 A peak (5 A range) ± 0.75 A peak (0.5 A range, ≥ 10 MHz) ± 0.3 A peak (0.5 A range, < 10 MHz)
Noise	75 μ Arms or less* ² (typical: 60 μ Arms)

*1: Maximum 2 sec input; requires cooling time of at least 10 times longer than the time current has been input
*2: Does not apply to devices to which the probe is connected; applicable in the 0.5 A range and when used with 20 MHz bandwidth instrument devices

Accuracy (amplitude)

Range	Accuracy	typical
30 A	$\pm 3.0\%$ of reading ± 1 mV	$\pm 1.0\%$ of reading ± 1 mV (≤ 10 A)
5 A	$\pm 3.0\%$ of reading ± 1 mV	$\pm 1.0\%$ of reading ± 1 mV
0.5 A	$\pm 3.0\%$ of reading ± 10 mV	$\pm 1.0\%$ of reading ± 10 mV

The accuracy above is valid within the following conditions:
Warm-up time: 30 minutes, operating environment of $23^{\circ}\text{C} \pm 5^{\circ}\text{C}$ ($73^{\circ}\text{F} \pm 9^{\circ}\text{F}$) at 80% RH or less, DC or sine wave signals of 45 to 66 Hz, within maximum peak current for each range

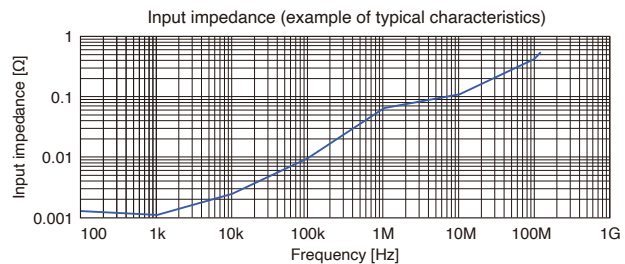
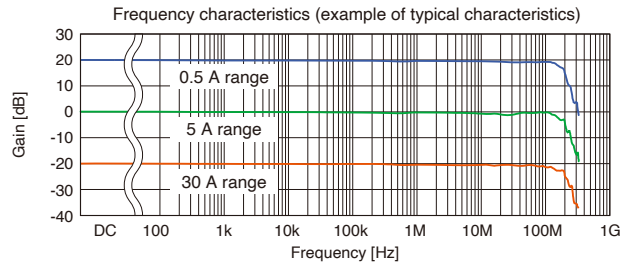
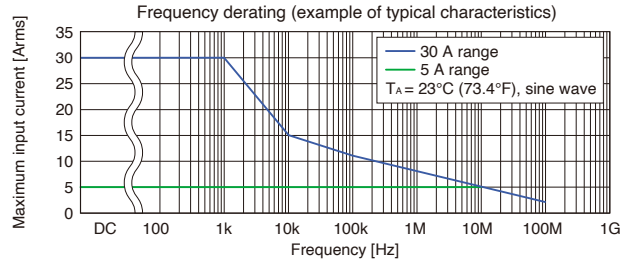

Operating temperature and humidity range	0°C to 40°C (32°F to 104°F), 80% RH or less (no condensation)
Storage temperature and humidity range	-10°C to 50°C (14°F to 122°F), 80% RH or less (no condensation)
Standards	Safety: EN 61010, EMC: EN 61326
Maximum rated power	7.8 VA (continuous maximum input)
Cable length	Sensor/junction box: 1500 mm (59.06 in.) Junction box/termination unit: 150 mm (5.91 in.) Power cord: 1000 mm (39.37 in.)
Dimensions	Sensor: 155 mm (6.10 in.) W x 18 mm (0.71 in.) H x 26 mm (1.02 in.) D Junction box: 45 mm (1.77 in.) W x 120 mm (4.72 in.) H x 25 mm (0.98 in.) D Termination unit: 29 mm (1.14 in.) W x 83 mm (3.27 in.) H x 40 mm (1.57 in.) D (excluding BNC connector or protrusions)
Weight	Approx. 370 g (13.1 oz.)

CT6700

Product warranty period: 1 year
Guaranteed accuracy period: 1 year



Rated current*	5 Arms
Frequency band	DC to 50 MHz (-3dB)
Diameter of measurable conductors	Max. ϕ 5 mm (0.20 in.) (insulated conductors)

*DC or sine wave signals of 45 to 66 Hz, within maximum peak current for each range

Rise time	7.0 ns or less (10% to 90%)
Output voltage	1 V/A
Maximum peak current	± 7.5 A peak (non-continuous)
Noise	75 μ Arms or less* (typical: 60 μ A rms)

*Does not apply to devices to which the probe is connected; applicable when used with 30 MHz bandwidth instrument devices

Accuracy (amplitude)

Accuracy	typical
$\pm 3.0\%$ of reading ± 1 mV	$\pm 1.0\%$ of reading ± 1 mV

The accuracy above is valid within the following conditions:
Warm-up time: 30 minutes, operating environment of 23°C \pm 5°C (73°F \pm 9°F) at 80% RH or less, DC or sine wave signals of 45 to 66 Hz, 0 Arms to 5 Arms

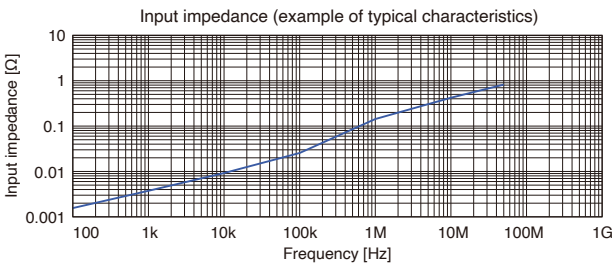
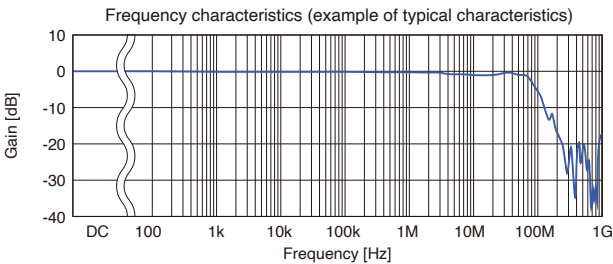
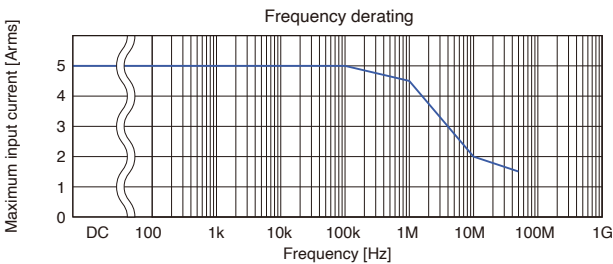

Operating temperature and humidity range	0°C to 40°C (32°F to 104°F), 80% RH or less (no condensation)
Storage temperature and humidity range	-10°C to 50°C (14°F to 122°F), 80% RH or less (no condensation)
Standards	Safety: EN 61010, EMC: EN 61326
Maximum rated power	3.2 VA (continuous maximum input)
Cable length	Sensor cable: 1500 mm (59.06 in.) Power cord: 1000 mm (39.37 in.)
Dimensions	Sensor: 155 mm (6.10 in.) W x 18 mm (0.71 in.) H x 26 mm (1.02 in.) D Termination unit: 29 mm (1.14 in.) W x 83 mm (3.27 in.) H x 40 mm (1.57 in.) D (excluding BNC connector or protrusions)
Weight	Approx. 250 g (8.8 oz.)

CT6701

Product warranty period: 1 year
Guaranteed accuracy period: 1 year



Rated current*	5 Arms
Frequency band	DC to 120 MHz (-3dB)
Diameter of measurable conductors	Max. ϕ 5 mm (0.20 in.) (insulated conductors)

*DC or sine wave signals of 45 to 66 Hz, within maximum peak current for each range

Rise time	2.9 ns or less (10% to 90%)
Output voltage	1 V/A
Maximum peak current	± 7.5 A peak (non-continuous)
Noise	75 μ Arms or less* (typical: 60 μ A rms)

*Does not apply to devices to which the probe is connected; applicable when used with 30 MHz bandwidth instrument devices

Accuracy (amplitude)

Accuracy	typical
$\pm 3.0\%$ of reading ± 1 mV	$\pm 1.0\%$ of reading ± 1 mV

The accuracy above is valid within the following conditions:
Warm-up time: 30 minutes, operating environment of 23°C \pm 5°C (73°F \pm 9°F) at 80% RH or less, DC or sine wave signals of 45 to 66 Hz, 0 Arms to 5 Arms

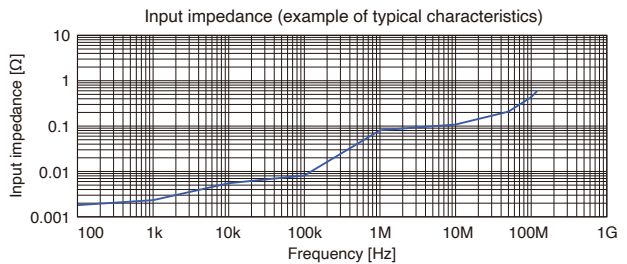
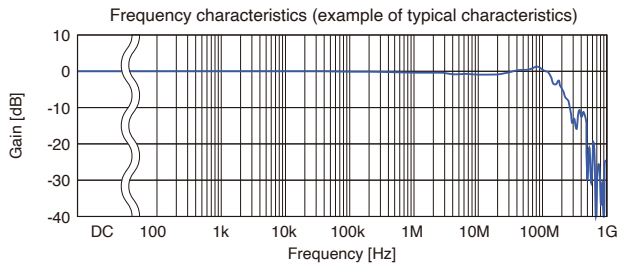
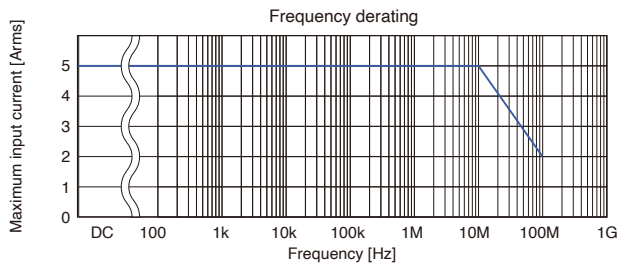

Operating temperature and humidity range	0°C to 40°C (32°F to 104°F), 80% RH or less (no condensation)
Storage temperature and humidity range	-10°C to 50°C (14°F to 122°F), 80% RH or less (no condensation)
Standards	Safety: EN 61010, EMC: EN 61326
Maximum rated power	3.2 VA (continuous maximum input)
Cable length	Sensor cable: 1500 mm (59.06 in.) Power cord: 1000 mm (39.37 in.)
Dimensions	Sensor: 155 mm (6.10 in.) W x 18 mm (0.71 in.) H x 26 mm (1.02 in.) D Termination unit: 29 mm (1.14 in.) W x 83 mm (3.27 in.) H x 40 mm (1.57 in.) D (excluding BNC connector or protrusions)
Weight	Approx. 250 g (8.8 oz.)

3273-50

Product warranty period: 1 year
 Guaranteed accuracy period: 1 year



Rated current*	30 Arms
Frequency band	DC to 50 MHz (-3dB)
Diameter of measurable conductors	Max. ϕ 5 mm (0.20 in.) (insulated conductors)

*Refer to the graph for frequency derating characteristics.

Rise time	7.0 ns or less
Output voltage	0.1 V/A
Maximum peak current	50 A peak (non-continuous)
Noise	2.5 mArms or less*

*Does not apply to devices to which the probe is connected;
 applicable when used with 20 MHz bandwidth instrument devices

Accuracy (amplitude)

to 30 Arms	to 50 A peak
$\pm 1.0\%$ of reading ± 1 mV	$\pm 2.0\%$ of reading

The accuracy above is valid within the following conditions:
 Warm-up time: 30 minutes, operating environment of 23°C \pm 5°C (73°F \pm 9°F) at 80% RH or less, DC or sine wave signals of 45 to 66 Hz, 0 Arms to 5 Arms

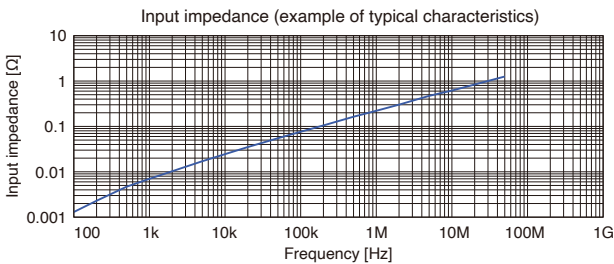
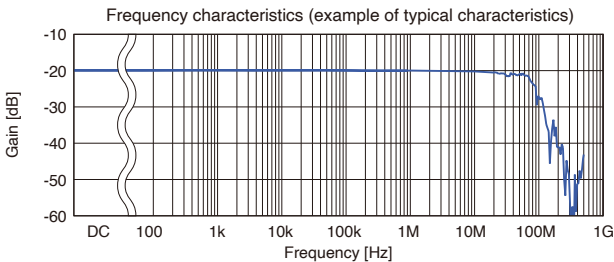
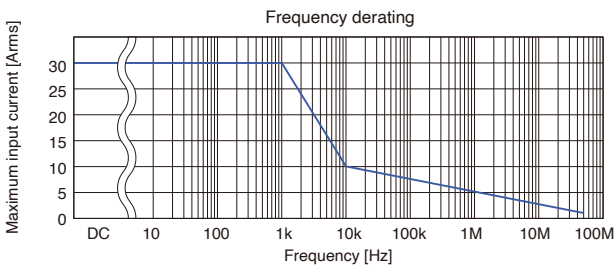

Operating temperature and humidity range	0°C to 40°C (32°F to 104°F), 80% RH or less (no condensation)
Storage temperature and humidity range	-10°C to 50°C (14°F to 122°F), 80% RH or less (no condensation)
Standards	Safety: EN 61010, EMC: EN 61326
Maximum rated power	5.6 VA
Cable length	Sensor cable: 1500 mm (59.06 in.) Power cord: 1000 mm (39.37 in.)
Dimensions	Sensor: 175 mm (6.89 in.) W \times 18 mm (0.71 in.) H \times 40 mm (1.57 in.) D Termination unit: 27 mm (1.06 in.) W \times 55 mm (2.17 in.) H \times 18 mm (0.71 in.) D (excluding BNC connector or protrusions)
Weight	Approx. 230 g (8.1 oz)

3276

Product warranty period: 1 year
 Guaranteed accuracy period: 1 year



Rated current*	30 Arms
Frequency band	DC to 100 MHz (-3dB)
Diameter of measurable conductors	Max. ϕ 5 mm (0.20 in.) (insulated conductors)

*Refer to the graph for frequency derating characteristics.

Rise time	3.5 ns or less
Output voltage	0.1 V/A
Maximum peak current	50 A peak (non-continuous)
Noise	2.5 mArms or less*

*Does not apply to devices to which the probe is connected;
 applicable when used with 20 MHz bandwidth instrument devices

Accuracy (amplitude)

to 30 Arms	to 50 A peak
$\pm 1.0\%$ of reading ± 1 mV	$\pm 2.0\%$ of reading

The accuracy above is valid within the following conditions:
 Warm-up time: 30 minutes, operating environment of 23°C \pm 5°C (73°F \pm 9°F) at 80% RH or less, DC or sine wave signals of 45 to 66 Hz, 0 Arms to 5 Arms

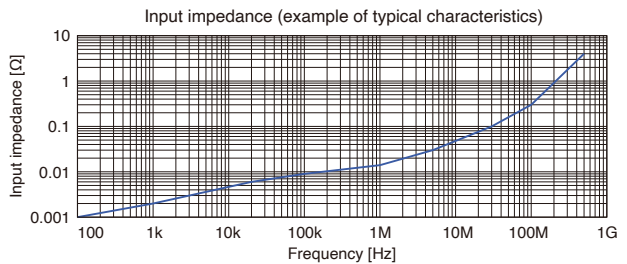
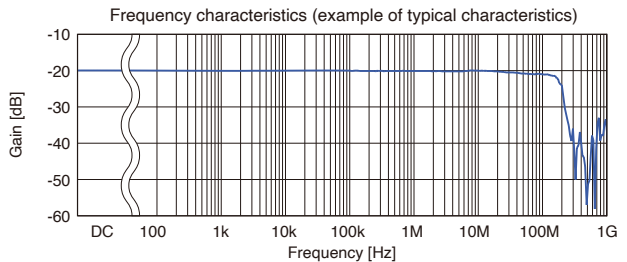
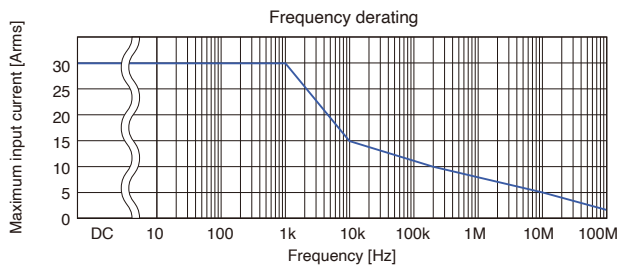

Operating temperature and humidity range	0°C to 40°C (32°F to 104°F), 80% RH or less (no condensation)
Storage temperature and humidity range	-10°C to 50°C (14°F to 122°F), 80% RH or less (no condensation)
Standards	Safety: EN 61010, EMC: EN 61326
Maximum rated power	5.3 VA
Cable length	Sensor cable: 1500 mm (59.06 in.) Power cord: 1000 mm (39.37 in.)
Dimensions	Sensor: 175 mm (6.89 in.) W \times 18 mm (0.71 in.) H \times 40 mm (1.57 in.) D Termination unit: 27 mm (1.06 in.) W \times 55 mm (2.17 in.) H \times 18 mm (0.71 in.) D (excluding BNC connector or protrusions)
Weight	Approx. 240 g (8.5 oz)

3274



Product warranty period: 1 year
Guaranteed accuracy period: 1 year

Rated current*	150 Arms
Frequency band	DC to 10 MHz (-3dB)
Diameter of measurable conductors	Max. ϕ 20 mm (0.79 in)(insulated conductors)

*The accuracy above is valid within the following conditions:
DC or sine wave signals of 45 to 66 Hz, within maximum peak current for each range

Rise time	35 ns or less
Output voltage	0.01 V/A
Maximum peak current	300 A peak (non-continuous)*1
Noise	25 mArms or less*2

*1: 500 A peak with pulse width \leq 30 μ s
*2: Does not apply to devices to which the probe is connected;
when used with a 20 MHz bandwidth instrument devices

Accuracy (amplitude)

to 150 A	to 300 A peak
$\pm 1.0\%$ of reading ± 1 mV	$\pm 2.0\%$ of reading

The accuracy above is valid within the following conditions:
Warm-up time: 30 minutes, operating environment of 23°C \pm 5°C (73°F \pm 9°F) at 80% RH or less, DC or sine wave signals of 45 to 66 Hz

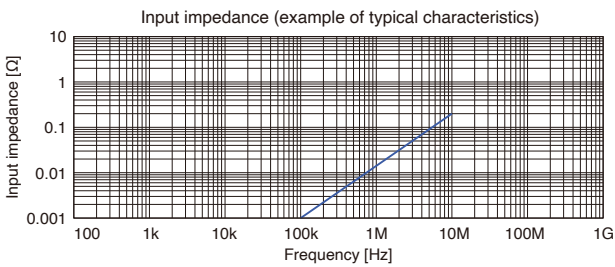
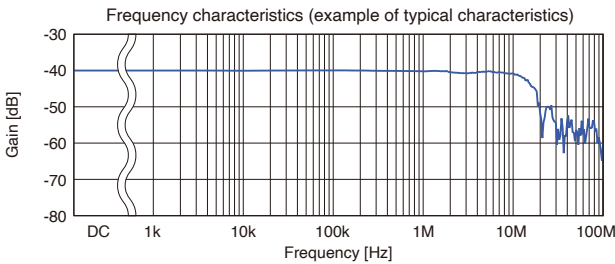
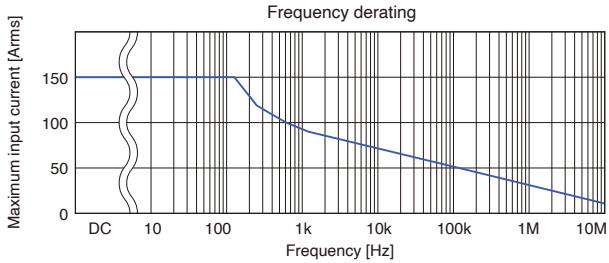

Operating temperature and humidity range	0°C to 40°C (32°F to 104°F), 80% RH or less (no condensation)
Storage temperature and humidity range	-10°C to 50°C (14°F to 122°F), 80% RH or less (no condensation)
Standards	Safety: EN 61010, EMC: EN 61326
Maximum rated power	5.5 VA (continuous maximum input)
Cable length	Sensor cable: 2000 mm (78.74 in.) Power cord: 1000 mm (39.37 in.)
Dimensions	Sensor: 176 mm (6.93 in.) W \times 69 mm (2.72 in.) H \times 27 mm (1.06 in.) D Termination unit: 27 mm (1.06 in.) W \times 55 mm (2.17 in.) H \times 18 mm (0.71 in.) D (excluding BNC connector or protrusions)
Weight	Approx. 500 g (17.6 oz)

3275



Product warranty period: 1 year
Guaranteed accuracy period: 1 year

Rated current*	500 Arms
Frequency band	DC to 2 MHz (-3dB)
Diameter of measurable conductors	Max. ϕ 20 mm (0.79 in)(insulated conductors)

*The accuracy above is valid within the following conditions:
DC or sine wave signals of 45 to 66 Hz, within maximum peak current for each range

Rise time	175 ns or less
Output voltage	0.01 V/A
Maximum peak current	700 A peak (non-continuous)
Noise	25 mArms or less*

*Does not apply to devices to which the probe is connected;
when used with a 20 MHz bandwidth instrument devices

Accuracy (amplitude)

to 500 A	to 700 A peak
$\pm 1.0\%$ of reading ± 5 mV	$\pm 2.0\%$ of reading

The accuracy above is valid within the following conditions:
Warm-up time: 30 minutes, operating environment of 23°C \pm 5°C (73°F \pm 9°F) at 80% RH or less, DC or sine wave signals of 45 to 66 Hz

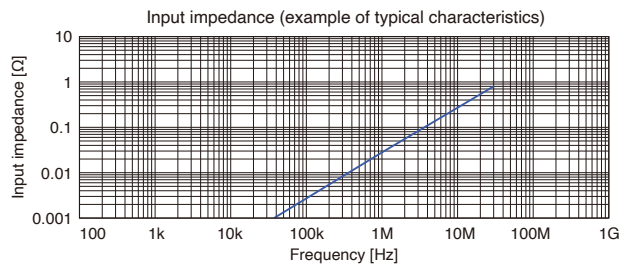
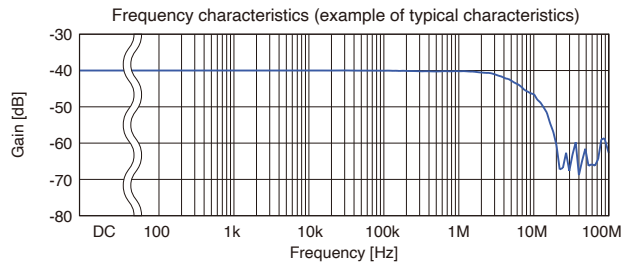
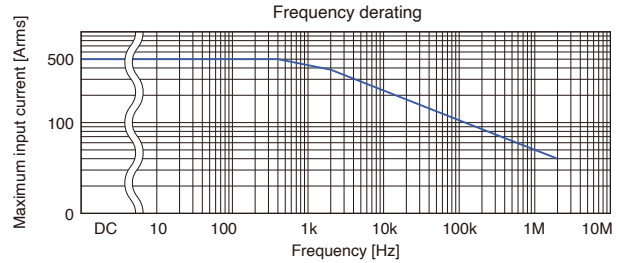

Operating temperature and humidity range	0°C to 40°C (32°F to 104°F), 80% RH or less (no condensation)
Storage temperature and humidity range	-10°C to 50°C (14°F to 122°F), 80% RH or less (no condensation)
Standards	Safety: EN 61010, EMC: EN 61326
Maximum rated power	7.2 VA (continuous maximum input)
Cable length	Sensor cable: 2000 mm (78.74 in.) Power cord: 1000 mm (39.37 in.)
Dimensions	Sensor: 176 mm (6.93 in.) W \times 69 mm (2.72 in.) H \times 27 mm (1.06 in.) D Termination unit: 27 mm (1.06 in.) W \times 55 mm (2.17 in.) H \times 18 mm (0.71 in.) D (excluding BNC connector or protrusions)
Weight	Approx. 520 g (18.3 oz)

High-accuracy measurement (ME15W)		
Pass-through types	Rated current	Frequency range
CT6862-05	50 A	DC to 1 MHz
CT6872	50 A	DC to 10 MHz
CT6872-01	50 A	DC to 10 MHz
CT6863-05	200 A	DC to 500 kHz
CT6873	200 A	DC to 10 MHz
CT6873-01	200 A	DC to 10 MHz
CT6875A	500 A	DC to 2 MHz
CT6875A-1	500 A	DC to 1.5 MHz
CT6904A	500 A	DC to 4 MHz
CT6904A-1	500 A	DC to 2 MHz
CT6904A-2	800 A	DC to 4 MHz
CT6904A-3	800 A	DC to 2 MHz
CT6876A	1000 A	DC to 1.5 MHz
CT6876A-1	1000 A	DC to 1.2 MHz
CT6877A	2000 A	DC to 1 MHz
CT6877A-1	2000 A	DC to 1 MHz
Clamp types	Rated current	Frequency range
9272-05	20 A, 200 A	1 Hz to 100 kHz
CT6841A	20 A	DC to 2 MHz
CT6843A	200 A	DC to 700 kHz
CT6844A	500 A	DC to 500 kHz
CT6845A	500 A	DC to 200 kHz
CT6846A	1000 A	DC to 100 kHz
Direct-wired types	Rated current	Frequency range
PW9100A-3	50 A	DC to 3.5 MHz
PW9100A-4	50 A	DC to 3.5 MHz

Connection options	
CT9555	1 ch, external power supply, with waveform output function
CT9556	1 ch, external power supply, with waveform/RMS output function
CT9557	4 ch, external power supply, includes waveform/aggregated-waveform/aggregated-RMS output functions
L9217	Isolated BNC terminals
9165	Metallic BNC terminals
CT9904	Used with CT9557 added waveform output
CT9901	Converts ME15W terminal to PL23 terminal
CT9902	Used to extend cable length

Waveform observation (BNC)		
High-sensitivity observation	Rated current	Frequency range
CT6710	0.5 A, 5 A, 30 A	DC to 50 MHz
CT6711	0.5 A, 5 A, 30 A	DC to 120 MHz
Observation of minuscule currents	Rated current	Frequency range
CT6700	5 A	DC to 50 MHz
CT6701	5 A	DC to 120 MHz
Observation of large currents	Rated current	Frequency range
3273-50	30 A	DC to 50 MHz
3276	30 A	DC to 100 MHz
3274	150 A	DC to 10 MHz
3275	500 A	DC to 2 MHz
Connection options		
3269	4 ch, external power supply, total output 2.5 A	
3272	2 ch, external power supply, total output 600 mA	

Grid power quality control (PL14)		
Measurement of load current	Rated current	Frequency range
CT7126	60 A	40 Hz to 2 kHz
CT7131	100 A	40 Hz to 2 kHz
CT7731	100 A	DC to 5 kHz
CT7631	100 A	DC to 10 kHz
CT7736	600 A	DC to 5 kHz
CT7636	600 A	DC to 10 kHz
CT7136	600 A	40 Hz to 5 kHz
CT7742	2000 A	DC to 5 kHz
CT7642	2000 A	DC to 10 kHz
Measurement of large currents	Rated current	Frequency range
CT7044	6000 A	10 Hz to 50 kHz
CT7045	6000 A	10 Hz to 50 kHz
CT7046	6000 A	10 Hz to 50 kHz
Measurement of leakage current	Rated current	Frequency range
CT7116	6 A	40 Hz to 5 kHz
Connection options		
CT9920	Converts PL14 terminal to ME15W terminal	
L9095	Connects CM7290, CM7291 and instrument	
L0220-01	Extends a cable with a PL14 terminal, 2 m (6.56 ft.)	
L0220-02	Extends a cable with a PL14 terminal, 5 m (16.40 ft.)	
L0220-03	Extends a cable with a PL14 terminal, 10 m (32.81 ft.)	
L0220-04	Extends a cable with a PL14 terminal, 20 m (65.62 ft.)	
L0220-05	Extends a cable with a PL14 terminal, 30 m (98.43 ft.)	
L0220-06	Extends a cable with a PL14 terminal, 50 m (164.04 ft.)	
L0220-07	Extends a cable with a PL14 terminal, 100 m (328.08 ft.)	

Grid power quality control (BNC)		
Measurement of load current	Rated current	Frequency range
9694	5 A	40 Hz to 5 kHz
9695-02	50 A	40 Hz to 5 kHz
9660	100 A	40 Hz to 5 kHz
9695-03	100 A	40 Hz to 5 kHz
9010-50	10 A - 500 A*1	40 Hz to 1 kHz
9018-50	10 A - 500 A*1	40 Hz to 3 kHz
9132-50	20 A - 1000 A*2	40 Hz to 1 kHz
CT6500	500 A	40 Hz to 1 kHz
9661	500 A	40 Hz to 5 kHz
9669	1000 A	40 Hz to 5 kHz
Measurement of large currents	Rated current	Frequency range
CT9667-01	500 A, 5000 A	10 Hz to 20 kHz
CT9667-02	500 A, 5000 A	10 Hz to 20 kHz
CT9667-03	500 A, 5000 A	10 Hz to 20 kHz
Measurement of leakage current	Rated current	Frequency range
9657-10	10 A	40 Hz to 5 kHz
9675	10 A	40 Hz to 5 kHz
Connection options		
9219	Converts crimped terminal to BNC terminal	
L9910	Converts BNC terminal to PL14 terminal	
9704	Converts BNC terminal to banana terminal	

*1: Can switch between ranges (10, 20, 50, 100, 200, 500 AAC)
*2: Can switch between ranges (20, 50, 100, 200, 500, 1000 AAC)

Note: Company names and product names appearing in this brochure are trademarks or registered trademarks of various companies.

HIOKI
HIOKI E. E. CORPORATION

HEADQUARTERS
81 Koizumi,
Ueda, Nagano 386-1192 Japan
<https://www.hioki.com/>



Scan for all regional contact information