

CONTENTS

	INTRODUCTION.....	3
SECTION 1	COMPONENTS	5
SECTION 2	PRODUCT DESCRIPTION	7
SECTION 3	KEYBOARD FUNCTIONS	11
SECTION 4	DEVICE OPERATION	13
SECTION 5	INSTRUCTIONS FOR MEASUREMENTS	17
SECTION 6	MEASUREMENTS.....	21
SECTION 7	LIST OF AVAILABLE SPECIES AND ADDING NEW TYPES OF GRAIN.....	27
SECTION 8	UPDATING VIA USB	29
SECTION 9	MODIFICATION OF MOISTURE INDICATIONS	31
SECTION 10	SETTINGS.....	35
SECTION 11	BATTERY REPLACEMENT	43
SECTION 12	FINAL NOTES	45
SECTION 13	TECHNICAL DATA.....	47

INTRODUCTION

EN

Thank you for choosing the new Draminski GMM mini grain moisture meter. This excellent device will be very useful in your activity. It is small and light, easy to take to the field, and gives quick and precise measurements, allowing to determine the exact grain moisture.

Innovative solutions, state-of-the-art technology and great versatility due to the possibility of updating through the USB port, make it a good long-term investment.

Increase your crops and enjoy your work with the Draminski GMM mini grain moisture meter.

The manufacturer – DRAMIŃSKI S.A. offers its users great knowledge and reserves the right to introduce hardware and firmware modifications. DRAMIŃSKI S.A. reserves the right to amend the contents of this instruction manual.

Read this instruction manual thoroughly before putting this device into operation. It will guarantee the safety of operation as well as long and reliable functioning of the tool.

Declaration of conformity is available for review at the seat of DRAMIŃSKI S.A. at 17 Owocowa st., 10-860 Olsztyn, Poland.

For more information and data, visit our website

www.draminski.com

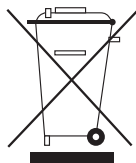

Please note that electronic equipment and batteries must not be disposed of in household waste containers. Used equipment and appliances should be delivered to special disposal facilities, according to the valid regulations. Proper waste disposal helps to save the natural environment.

COMPONENTS

EN

SECTION **1**

COMPONENTS:

1. Draminski GMM mini grain moisture meter
2. mini-USB port rubber cap
3. 2 AA type batteries, 1.5 V (LR6)
4. reusable transport packaging (made of plastic)
5. special dispenser with a damper
6. instruction manual
7. USB cable for computer connection



PRODUCT DESCRIPTION

EN

SECTION **2**

PRODUCT DESCRIPTION

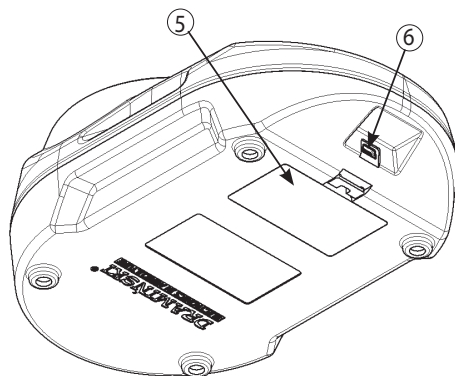
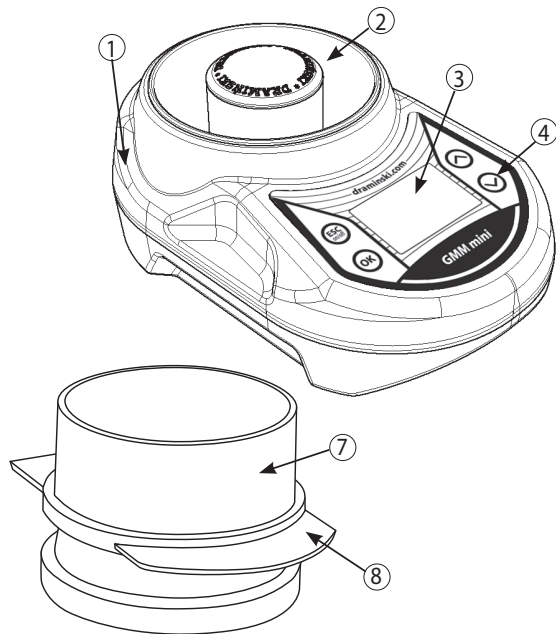

1. heavy duty ABS plastic casing
2. measuring chamber with digital temperature sensor
3. graphic LCD display with LED backlight
4. membrane keyboard
5. battery compartment for 2 AA type batteries, 1.5V (LR6)
6. mini-USB port with rubber dust cap
7. dispenser
8. dispenser damper

APPROXIMATE DIMENSIONS

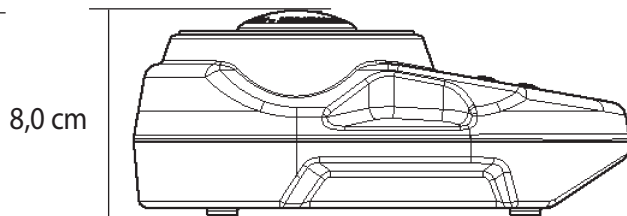
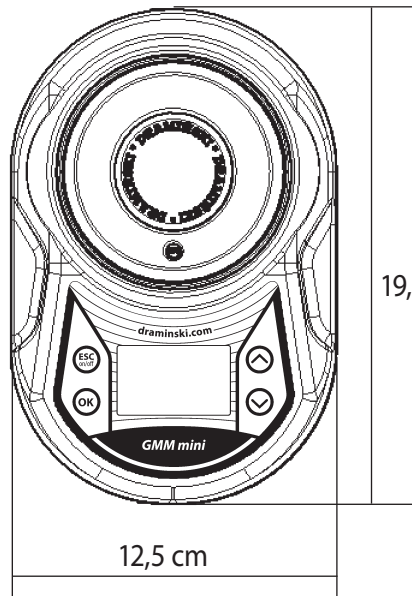

EN

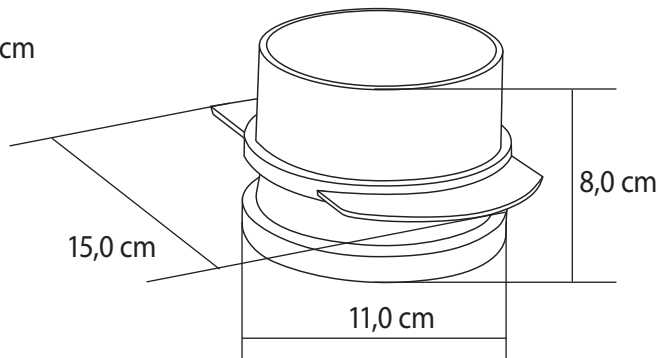



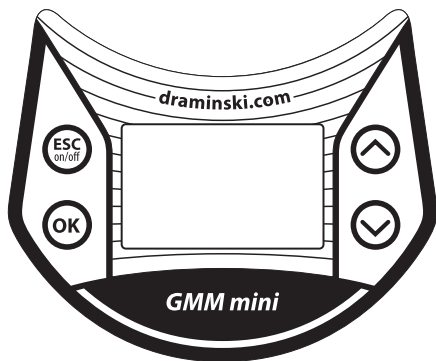

KEYBOARD FUNCTIONS

EN

SECTION **3**



	<ul style="list-style-type: none"> - device on/off - hold for 5 seconds to switch off the device (Note: the GMM mini can be switched off also by using the menu option "Shut-down". If the device is not in use for a long time, it will switch off automatically to save the batteries) - hold for 2 seconds to switch on the main menu - program function cancel
	<ul style="list-style-type: none"> - program function enter - measuring program start
	<ul style="list-style-type: none"> - menu scrolling - setting values of menu options - grain selection from the list
	<ul style="list-style-type: none"> - delete average result in given sample moisture measurement

DEVICE OPERATION

EN

SECTION **4**

The GMM mini is ready for use when batteries are properly installed in their compartment (check polarity).

Switch on the device using .

- a) a welcome message will be displayed, showing the device name, software version, calibration version and serial number:

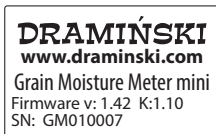

- b) next, a list of available species will be displayed and device model and current battery status will appear in the upper part of the screen (recently tested species will be backlit):

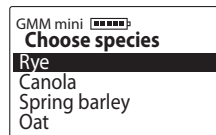

Caution! If batteries are too weak to continue work, the device will display the following message:

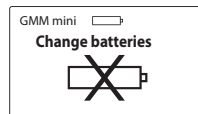

which indicates that batteries must be replaced.

- c) in order to save batteries, when no key is pressed for a certain time, the device will go to a standby mode and the backlight will turn off (that time can be changed through the proper menu option – see SETTINGS section). Press any button to return to the operation mode.

d) if the GMM mini remains in the standby mode for several minutes, it will shut off automatically (time setting possible in menu). Countdown from 10 to 0 will display on the screen – press any button to stop, or the device will shut off automatically to save power:



e) for manual switch off, hold  button for 5 seconds, or select "**Turn off!**" in the main menu.

INSTRUCTIONS FOR MEASUREMENTS

EN

SECTION **5**

Following the manual as well as experience gained in time will largely facilitate reaching the expected accuracy and repetition of sample moisture measurements.

– size of grains and purity of test sample determine obtaining a correct result. Chaff, screenings and dirt content within the sample should be as low as possible.

– water remaining on top of the sample (e. g. dew) can affect measurement result. Samples should be aired before measurement to avoid it,

– the dispenser included in the set must be used to dose a proper amount of grain because the way the measuring chamber is filled is important and determines measurement accuracy. Fill the dispenser with small surplus and remove the damper always the same way,

– while measuring, when „Chamber empty?“ message displays, check whether the chamber is empty, clean and dry and then press  button to confirm, because the device reads the parameters of the chamber before it is filled with grain,

– the final result of measuring should be the average value of e.g. 3 recent tests of a given sample, which is calculated automatically and displayed in the bottom right corner of the screen (number of measurements used for calculation of the average value can be changed in the menu),

– make sure that the measuring chamber temperature is the same as the sample temperature (do not pour cool grain into hot device (e.g. after being exposed to sunlight) and vice-versa). The temperature sensor may react with a certain delay, since the measurement chamber walls have brass lining,

– each species has a different range of measured moisture. Results beyond the set range are marked with a proper sign:

„<**8.5%**” (below the range), when moisture of tested sample is lower than 8.5%,

„>**35.0%**” (above the range), when moisture of tested sample is higher than 35%,

– if significant departures are found in the result for a given species, either too high or too low by a similar value within the entire measurement range in comparison with the drying-and-weighing test method, indications must be modified (see: MODIFYING MOISTURE INDICATIONS).

MEASUREMENTS



EN

SECTION 6

In order to measure grain moisture:

- a) switch the device on using  button. After a short welcome message, the list of available species will appear on screen. The GMM mini will always indicate the name of the recently selected species e.g Canola:



- b) use  or  button to select the species to be tested and confirm with 
- c) when proper grain is selected, the device will ask if the measurement chamber is empty and display the current chamber temperature:

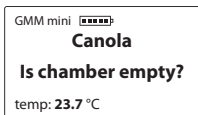

at that point, check if the measurement chamber is really empty and clean. Confirm with  button,

- d) when the status is confirmed, "**Wait!**" message will be displayed for 1 second:



do not touch the measurement chamber or put anything inside when that message is displayed because the device has to read the chamber parameters before sample insertion, in order to improve the measurement accuracy.

- e) now the device is ready for sample insertion. Use the dispenser to place grain inside the chamber. (Placing the device on an even and firm foundation is recommended)



Filling the measurement chamber using the dispenser:

Place the damper in the dispenser slot until it locks. Place grain inside the dispenser with a small surplus.

CAUTION!

If the dispenser is not filled completely, large measurement error may occur. Overfilling has smaller effect on the result.

Do not compress grain in the dispenser.



When these actions are completed, place the filled dispenser on the chamber (bottom edge of the dispenser is specially profiled to match the GMM mini casing). Then remove the damper to fill the measurement chamber with grain.

CAUTION!

To fill the measurement chamber, remove the damper with a quick and smooth movement within around 1 second (it is important that the damper is removed always the same way).

When pouring flour, remove the damper slowly, for 2-3 seconds, letting flour to pour in portions into the chamber.

Upper edges of the measurement chamber must be completely covered.

f) after filling the measurement chamber, the GMM mini will automatically display „**Press OK**”



do not move or shake the device after that, just press **OK**.

The dispenser should stay on the device until the result is displayed.

g) after confirming with **OK**, the device will display „**Analysing**” message. After 2 seconds moisture measurement result (%) and sample temperature will appear (temp. in °C or °F, as set by the user):

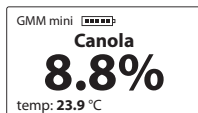

the displayed result reflects temperature effect (automatic temperature compensation)

CAUTION!

Pour grain into the chamber only if the display shows „**Pour in sample**” message



h) when the measurement is completed, empty the chamber and press **OK** to start a new measurement procedure (follow the messages displayed on screen), or press **ESC on/off** to return to the list and select another species.

CAUTION!

The measurement chamber must be cleaned carefully when changing the tested grain type and when testing samples with varied or high moisture.

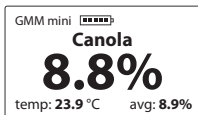
i) the final result of moisture measurement should be the average of e.g. 3 recent tests of a given sample. The device determines the average value automatically and displays it in the bottom right corner of the screen



the number of measurements used for calculation of the average value can be changed in the main menu (see SETTINGS section). Results above and below the set range are not included in the average value. In order to start calculating a new average value, press  to clear or return to the list of species using 

j) when measurements are completed, switch off the device to save batteries, holding  button for 5 seconds or by selecting “**Turn off!**” option in the main menu.

LIST OF AVAILABLE SPECIES AND ADDING NEW TYPES OF GRAIN

EN

SECTION **7**

The Draminski GMM mini grain moisture meter is capable of storing in its memory a few hundred different types of grain to be used in measurements. The list of available species may vary in each device, depending on current offer in the country of purchase.

Current list of all available species is available on the manufacturer's website **www.draminski.com** in **Products / Moisture Meters / GMM mini**.

Users of the Draminski GMM mini grain moisture meters may activate additional species by entering a special code in the main menu, after selecting the option "**Add species**" (see: SETTINGS). In order to get the special activation code for a chosen grain type, please contact us:

e-mail: wilgo@draminski.com

tel: +48 89 527 11 30

or your local authorised distributor of Draminski products.

Contact us if you have a grain type not included in the list on our website or a special grain type that you would like to test. We are open for remote cooperation to add new species configured according to your needs, that could be activated in your device using a special code.

These unique possibilities make the GMM mini a universal device that will offer its unlimited capabilities even after many years of use.

UPDATING VIA USB

EN

SECTION 8

The Draminski GMM mini is equipped with a mini-USB port that allows the user to update the firmware, data stored in the device memory, list of available language versions and also activate new functions of the device, or change the list of available species.

Check availability of new updates on the manufacturer's website **www.draminski.com** in **Products / Moisture Meters / GMM mini**.

To get through the update procedure, follow the step-by-step guide available on our website.

Our programmers have strived for making the update as easy as possible, so even most inexperienced users will be able to do it.

Any questions or doubts? Do not hesitate to contact our specialists:

e-mail: wilgo@draminski.com

tel: +48 89 527 11 30

MODIFICATION OF MOISTURE INDICATIONS

EN

SECTION 9

The Draminski GMM mini grain moisture meter stores moisture curves for each species, determined on the basis of results for normalised samples (bulk density of grain and mass of 1000 seeds), which guarantees accurate and repeatable results. However, it may happen that crop of a given year varies from normalised seeds (due to various factors) and departures may occur in moisture indications.

Such factors include:

1. seed formation and maturity
 - weak and badly formed seeds = results underrated,
2. specific features of a given grain
 - very tiny seeds = results underrated,
 - very large seeds = results overrated,
3. degree of contamination and screenings = results usually underrated,
4. degree of damage caused by pests and fungi.

NOTE!

Results of measurements should be compared only with the laboratory drying-and-weighing test, not with results of other moisture meters, as they may be misleading.

The Draminski GMM mini grain moisture meter enables the user to modify (adjust) measurement indications.

In any case of modification, each grain type is treated individually. When a modification is made, an asterisk (*) will be displayed next to the grain name, while during the measurement, a note will be displayed in the upper right corner of the screen, showing the value of adjustment of indication for a given grain (the result will automatically reflect the modification):

before

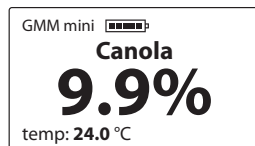

after

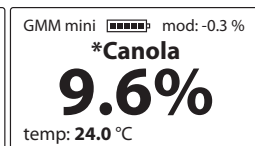

We recommend restoring factory settings in each following year and make another adjustment of indications (modification) if required. When factory settings are restored, the asterisk (*) next to the grain name disappears.

For a step-by-step guide for modification of moisture indications see SETTINGS section.





SETTINGS

EN

SECTION 10

Functions included in the main menu of the device enable the user to switch off the device quickly, adjust settings to individual needs, add new species and much more. In order to access the **MAIN MENU**, hold  button for 2 seconds.





1. Turn off!

To switch off the device, go to the **Main Menu** using  and press  or  to select the **Turn off!** option. Confirm with .



This function allows the user to switch the device off in a quick and comfortable way, without the necessity to hold  for 5 seconds or to wait until the automatic shutdown option activates.

2. List of species

To return to the list of species from the **Main menu**, use  or select the Species list option using  or  buttons. Confirm with .





3. Settings





3.1. International:



- 3.1a) language – to change the language version of the system, select **Main menu / Settings / International / Language**, and choose the language version using  or  buttons. Confirm with :





- 3.1b) temperature scale – to switch between Celsius and Fahrenheit scale, select **Main menu / Settings / International / Temperature scale**, choose proper temperature scale using  or  buttons and confirm with :

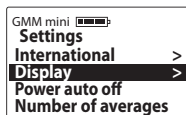

3.2 Display



- 3.2a) backlight intensity – the device has an energy-saving LED-backlit display, however you should remember that setting stronger backlight results in faster battery discharge. To change display backlight intensity, go to **Main menu / Settings / Display / Backlight intensity** and select required value using  or  buttons. Confirm your selection with :

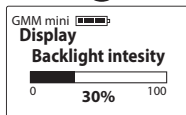

3.2b) backlight off time – adjust the time after which the display backlight turns off until any button is pressed again (the time is measured after the last use of any keyboard button). To modify backlight time, go to **Main menu / Settings / Display / Backlight off time**, select required value using \downarrow or \uparrow buttons and confirm with OK :

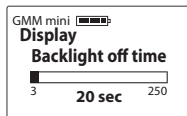

3.2c) contrast – in order to change display contrast, go to **Main menu / Settings / Display / LCD contrast**, select required value using \downarrow or \uparrow buttons and confirm with OK :

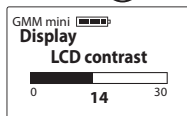

3.3 Power auto off

Adjustment of time after which the device shuts down automatically, starting from the last use of any keyboard button. To change the automatic shut-down time, go to **Main menu / Settings / Power auto off**, select required value using \downarrow or \uparrow buttons and confirm with OK :

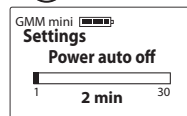

3.4 Numbers of averages

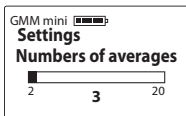
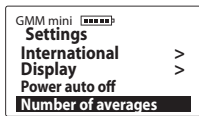

The device automatically calculates the average of recent measurements. In order to determine how many measurements should be included in the average, go to **Main menu / Settings / Numbers of averages**, select required number using \downarrow or \uparrow buttons and confirm with OK :

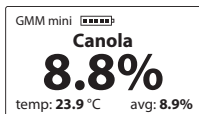

The average value will appear in the bottom right corner of the screen (after the third measurement, if the averaging count is set to „3“):





NOTE!

To clear the average value, hold  button until the device displays „Clear average?“. Press  to confirm, or  to cancel (the average will also clear if you return to the list and select another species).

4. Result modification

Before modifying (adjusting) moisture indications, read **MODIFICATION OF MOISTURE INDICATIONS** section.

To modify indications for a given type of grain, go to **Main menu / Result modification**, use  or  button to select grain to be modified and determine the value of moisture indication increase or decrease. Confirm your selection with  :

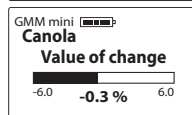
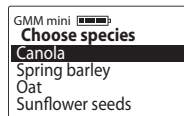

When modification is made, an asterisk (*) appears next to the grain name, informing on the alteration of factory settings. During the measurement, the modification value will be displayed in the upper right corner of the screen:

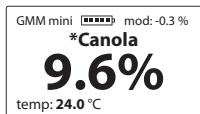

To restore factory settings, set the modification value to "0.0%", the asterisk beside the grain name will disappear:

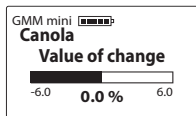

5. Add species

Before adding a new type of grain, see LIST OF AVAILABLE SPECIES AND ADDING NEW TYPES OF GRAIN.

To add a new type of grain to the list installed in the device, go to **Main menu** using **ESC** (on/off), then select **Add species** option using **↓** or **↑** buttons and confirm with **OK**:







To enter the special code, select appropriate characters using **↓** or **↑** buttons and confirm with **OK** (use „<“ to delete characters, confirm with **OK**).

When all characters are entered, the device will ask for confirmation. Press **OK** to confirm:



Caution! re-entering the same code will result in removing the given grain type from the list available in the device. Codes are dedicated for one device – to activate a new grain type in two GMM mini moisture meters, you will need two different codes.

6. About

In order to check device data and contact details of the manufacturer, go to **Main menu** using  and select the option **About** using  or  buttons. Press  to confirm.

This option allows the user to view the device model, firmware version, serial number and (on page 2) address and contact details of the manufacturer, DRAMIŃSKI S.A.



BATTERY REPLACEMENT

EN

SECTION 11

The device gives an automatic warning when batteries are discharged. In such case, immediately after switch-on or during the use a graphic symbol and a message will display. After that, the GMM mini will switch off automatically.

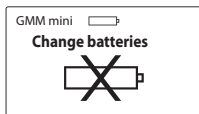

The moisture meter is powered with two AA type batteries 1.5V (LR6).

In order to change batteries:

- unlock the battery compartment cover on the underside and remove discharged batteries by pulling up the ribbon,
- place the ribbon inside the battery compartment,
- install new batteries according with their polarity signs +/- (pressing the ribbon inside),
- close the battery compartment with the cover.

Press it carefully until it locks with a click, which indicates that the battery compartment is properly secured and there is no risk of batteries falling out.

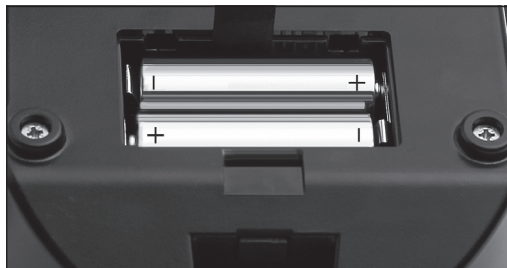
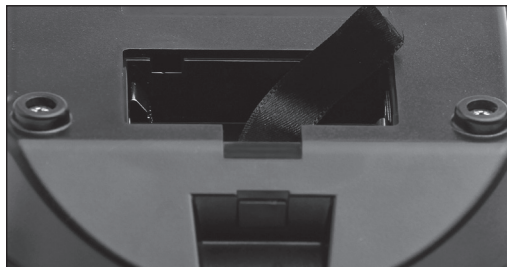

FINAL NOTES

EN

SECTION 12

- Protect your grain moisture meter against direct exposure to water. Avoid operating the device in extreme temperatures. Do not allow moisture condensing out of the air to accumulate on metal parts of the device, as it may affect measurements.
- At the end of the season, clean and dry the measuring chamber carefully. Leaving the device dry guarantees long and reliable operation.
- Store the device in dry and warm conditions.
- Before any prolonged storage, remove batteries from their compartment in order to eliminate the risk of damage caused by battery leak. We recommend using batteries of leading manufacturers.
- In case of any problems with the device or difficulties in interpretation of the results, please contact the manufacturer DRAMIŃSKI S.A. or your local authorised distributor before sending the device for repair.
- Do not dismantle the device on your own. Any modifications or repairs performed by unauthorised persons are unacceptable, as they may result in permanent damage and void the warranty.
- Always check if the mini-USB port rubber cap is in place, otherwise dirt might get inside and cause damage.

TECHNICAL DATA

EN

SECTION **13**

Approximate weight of device	700 g (with batteries)
Approximate weight of dispenser	140 g
Approximate dimensions	19.0 x 12.5 x 8.0 cm
Power source	2 AA type batteries 1.5 V (LR6)
Current battery status indicator	graphic
Battery discharge notification	automatic
Power consumption	8.5 mA up to 74 mA (depending on set backlight intensity)
Approximate length of continuous work on one set of batteries	270 hours, with backlight intensity set to 0% / 100 hours with backlight intensity set to 30%
Moisture measurement method	capacity
Measurement control	Single-chip microcomputer
Measurement chamber filling method	Manual, using a dedicated dispenser
Sample volume	270 ml
Moisture measurement accuracy	±1% in range up to 10% / ±1.5% in range above 10% and may increase along with sample moisture
Temperature measurement range	-10 °C up to +85 °C / 14 °F up to 185 °F
Temperature indication resolution	0.1 °C / 0.1 °F
Temperature indication accuracy	± 0.5 °C / ± 0.9 °F
Display	graphic LCD with LED backlight, display size 2"
Keyboard	membrane
Update	through USB
Data storage	Internal memory
Internal memory capacity	over 400 species in 40 language versions
Additional functions	automatic temperature compensation, pop-up menu, display parameters setting, language version selection, temperature scale selection, auto-off time adjustment, data and firmware update
Recommended operating temperature range	10 °C up to 35 °C / 50 °F up to 95 °F
Recommended storage temperature	5 °C up to 45 °C / 41 °F up to 113 °F