



MFG-2000 Series

Multi-Channel Function Generator

FEATURES

- **Maximum Five Channels Output**
Two Equivalent Performance Channels
Full-function Pulse Generator
Full-function RF Signal Generator
Power Amplifier Can be Output Simultaneously
- The Frequency Range of AFG Channel is From 1mHz~10/20/30/60MHz
- AM, FM, PM, ASK, FSK, PSK, SUM and PWM Modulation Functions
- The Output Frequency Bandwidth of RF Channel : 160/320MHz
- RF Channel Including FG/ARB/Modulation Functions
- Pulse Generator Reaches 25MHz
- Low Frequency Power Amplifier is 100kHz and Its Output Power is 20W
- Genuine Point-by-point Output Arbitrary Waveform Function Features
- Arbitrary Waveform Function Features 200MSa/s, 100 Waveform Repetition Rate, 14 bit Resolution and 16k Point Memory Depth
- Circuit Design for Ground Isolation Among Output/Input Terminals and Instrument Chassis
- Provide USB Host/USB Device/LAN Interface (LAN is only on MFG-22XX Series)
- 4.3 Inch TFT Color Display

GW Instek rolls out the MFG-2000 series multi-channel function generator, which has up to 5 simultaneous output channels, including CH1 and CH2 equivalent performance dual channel arbitrary function generator with the maximum 60MHz for both channels; RF signal generator, a standard AFG, which produces the maximum 320MHz sine wave and various modulation RF signals; pulse generator, whose frequency reaches 25MHz; power amplifier, which is ideal for audio range. The above-mentioned five different functionality channels are separately or totally allocated on 10 models, which extend from the basic single-channel AFG with pulse generator models to five-channel models so as to satisfy various educational and industrial applications.

The AFG channel of the MFG-2000 series outputs sine, square, and triangle, etc. The series features true point by point output arbitrary waveform characteristics of 200 MHz sample rate, 100MHz waveform repetition rate, 14 bit resolution, and 16k point memory depth. Some models provide various modulation methods such as AM/FM/PM/FSK/PWM, Sweep, Burst, Trigger, 150MHz Frequency Counter. Synchronized dual channel models provide correlated functions, including synchronization, delay, sum, and coupling. RF signal generator, a complete AFG signal source (including ARB), features various modulations, Sweep, and digital modulations such as ASK and PSK and its sine wave frequency is up to 320MHz. A full-function pulse generator with 25 MHz is equipped to all models and its pulse width, rise edge time, fall edge time are adjustable that can be applied as trigger signals. Independent input/output power amplifier with 20W, 10dB, DC-100KHz bandwidth, and distortion less than 0.1% can be applied to the audio application.

The overall design of the MFG-2000 series is earth ground isolation among output/input terminals and instrument chassis that can only be found in high-level signal sources. The output channels can sustain maximum isolation voltage up to $\pm 42V_{pk}$ (DC+ AC peak value) to earth ground that is ideal for floating circuit tests. Multi-unit outputs can be executed without factoring in grounding reference issue. There is no additional isolation requirement for experiments such as "full-wave rectification" and "voltage doubler" which are easy and safe. An external power supply can bring up the DC bias voltage to $\pm 42V_{pk}$ to meet the requirements of higher DC bias voltage such as automotive and educational applications.

The AFG of the MFG-2000 series collocating with AWES (Arbitrary Waveform Editing Software) allows users to easily and quickly edit arbitrary waveforms. DWR (Direct Waveform Reconstruction) allows users to collocate with GDS series digital oscilloscopes to retrieve waveforms and upload them to arbitrary generator to achieve direct waveform reconstruction. 66 built-in waveforms allow users to edit arbitrary waveforms and to output the whole segment or divided segments.

With the multi-functionality channels, the MFG-2000 series provides different industrial sectors with special dual channel waveforms, IQ modulation signals, low-frequency vibration simulation, automotive sensors, AM/FM broadcast signals, PWM motor or fan control signals, pulse synchronized signals, pulse noise, audio circuit or devices such as speaker tests. The series is ideal for various fields, including scientific research, education, research and development, production and quality control.

The MFG-2000 series can maximally and simultaneously output five functional channels. The functionalities of each channel are as follows:

Channel 1	1uHz-60MHz max. FG With 200MSa/s ARB	AM ,FM ,PM,FSK PWM ,Sweep ,Burst , Trigger, Frequency Counter	ASK,PSK
Channel 2	1uHz-60MHz max. FG With 200MSa/s ARB		
RF Channel	1uHz-320MHz max. FG With 200MSa/s ARB		
Pulse Generator	25MHz Full Function pulse Generator (Frequency /Width/duty Cycle /Rise and Fall Edge adjustable)		
Power Amplifier	20W Power Amplifier (20W (RL=8Ω)/20dB/DC-100kHz/<0.1% (Ampl >1Vpp 20Hz-20kHz)		

PANEL INTRODUCTION



1. TFT LCD Panel
2. Number Panel
3. Scroll Knob & Selection Key
4. Power switch
5. Output Terminal
6. Main Output Switch
7. Function Keys
8. Operation Keys
9. USB Host
10. Trigger & Modulation Input
11. Sync and Counter Input
12. Fan
13. Power Amplifier Input & Output
14. LAN (MFG-22XX only)
15. USB Device

A. CIRCUIT DESIGN FOR GROUND ISOLATION AMONG OUTPUT/INPUT TERMINALS AND INSTRUMENT CHASSIS

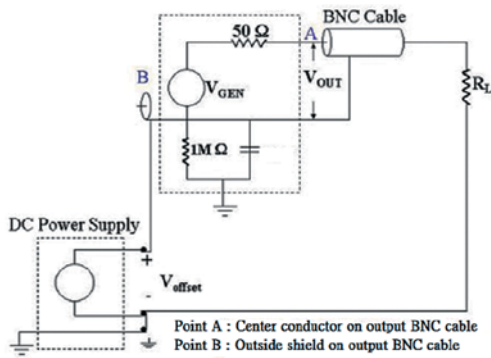

Connection diagram for MFG connecting with a power supply to increase D.C. bias voltage to $\pm 42V_{pk}$ (DC+ AC peak value).

Output channels, synchronization and modulation input/output connector grounding are isolated from instrument chassis. These connectors can sustain maximum isolation voltage up to $\pm 42V_{pk}$ (DC+ AC peak value) to earth ground that is ideal for floating circuit tests. Multi-unit outputs can be executed without factoring in grounding reference issue.

The built-in DC bias voltage of the MFG-2000 series can be applied on various waveforms. The DC bias voltage is $\pm 5V$ under 50 ohm load. An external power supply can be used to bring up the DC bias voltage to $\pm 42V_{pk}$ (DC+ AC peak value) for higher DC bias applications.

B. PULSE GENERATOR

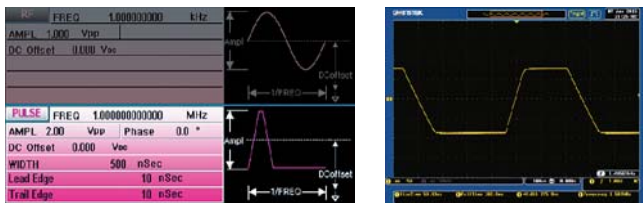

Each model of the series has a built-in pulse generator and its output frequency reaches 25 MHz. Users can set pulse width, duty cycle, rise edge time, fall edge time and edge time to support trigger signal.

C. RF SIGNAL GENERATOR

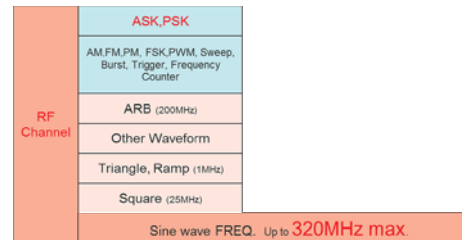

RF signal generator is a full function AFG signal source. Identical to CH1/CH2, it can output sine, square, ramp, pulse, noise, etc. Its sine wave frequency reaches 160MHz or 320MHz. And its true point by point output arbitrary waveform function supports 200 MHz sample rate, 100MHz waveform repetition rate, 14 bit resolution, 16k point memory depth, frequency sweep and various modulation methods such as AM/FM/PM/FSK/PWM/PSK/ASK. RF signal generator can be applied as a high frequency arbitrary waveform generator, simulated signals of analog or digital broadcast stations or carrier signals of local oscillator.

D. POWER AMPLIFIER

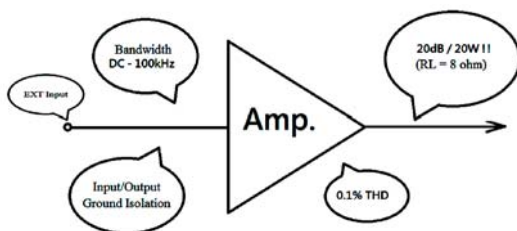

20W/20dB power amplifier, which has a bandwidth of DC ~ 100kHz and less than 0.1% distortion. The low frequency power amplifier can be applied as an audio amplifier or a driver amplifier for piezoelectric components (collocating with an impedance transformer, 20W output) and conducts power component characteristics tests, magnetization characteristics tests (B-H curve) of magnetic materials such as ferrite and amorphous materials (collocating with an impedance transformer, 20W output)

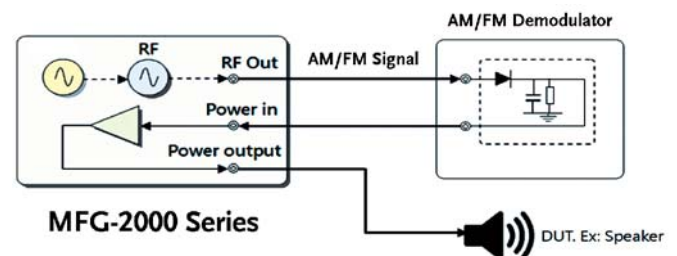

Users can connect a speaker with the low frequency power amplifier of the MFG-2000 series to realize various physics experiments.

E. VERSATILE OUTPUT WAVEFORM SELECTIONS

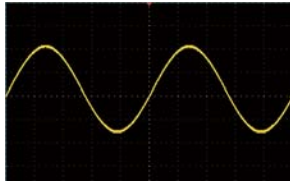

Sine

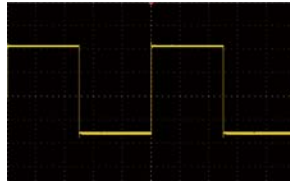

Square

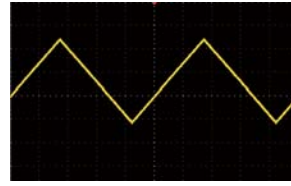

Triangle

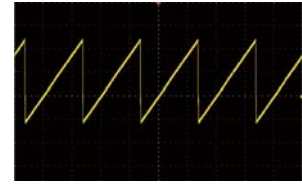

Ramp

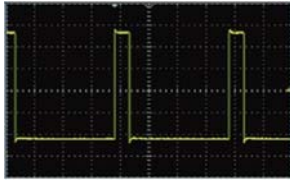

Pulse

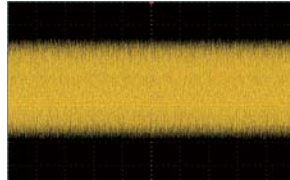

Noise



DC Voltage

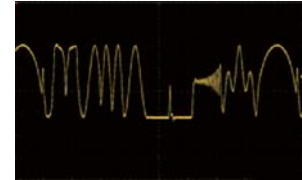

Arbitrary Waveform

There are standard waveforms for the series such as sine, square, triangle, ramp, pulse, noise, DC voltage. In addition,

66 built-in waveforms allow users to easily select desired waveforms.

F. VARIOUS MODULATION FUNCTION

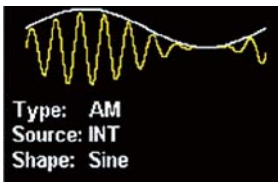

Amplitude Modulation

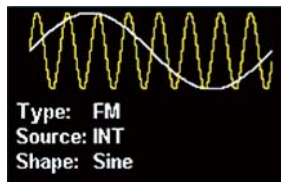

Frequency Modulation

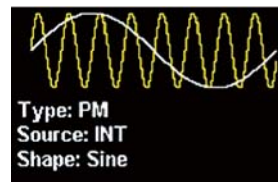

Phase Modulation

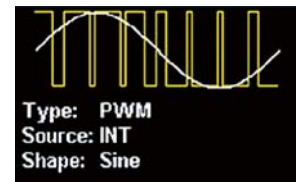

Pulse Width Modulation

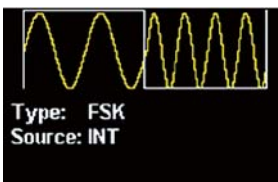

Frequency-shift Keying Modulation

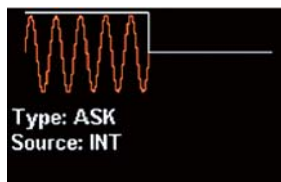

Amplitude-shift Keying Modulation

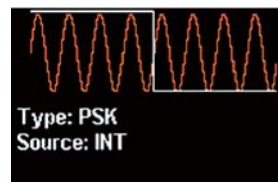

Phase-Shift Keying Modulation

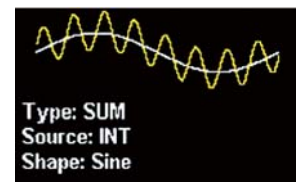

Sum Modulation

The series supports AM, FM, PM, FSK, PWM and SUM modulation. RF channel not only has the above-mentioned modulation capabilities but also supports advanced modulations such as ASK

and PSK Modulation. The most modulation sources can be internal or external. Applications include communications systems' base band, motor control and light adjustment.

G. SWEEP FUNCTION

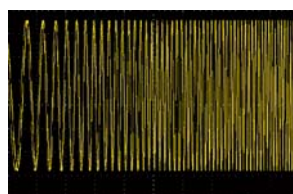
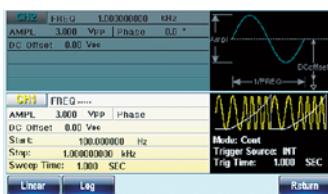

The series supports frequency sweep and amplitude sweep that can also integrate other functions, including linear/logarithm, one-way (saw tooth)/two-way (triangle) waveforms, continuous/single trigger/gated trigger to meet various application requirements by different sweep methods. Frequency sweep carries out tests on the frequency response of electronic components such as filter and low frequency amplifier.

H. BURST FUNCTION



The series supports N-period or gated trigger. Phase angle, duration time, frequency, waveform infinite can be adjusted to meet non-continuous output applications.

I. THE OUTPUT CORRELATED FUNCTIONS OF EQUIVALENT PERFORMANCE DUAL CHANNEL

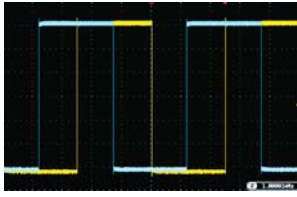

Differential Signal

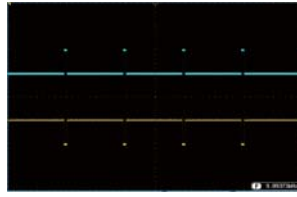

Sine and Cosine Signal

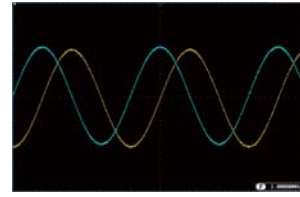

Square Wave Phase Setting

The CH1 and CH2 of MFG-2203M/2206M/2260MFA/2260MRA can be applied separately. These two channels provide four correlated functions, including sum, coupling, tracking and phase.

* The coupling function allows users to freely set ratio and offset values for frequency and amplitude of both channels to realize that all parameters are simultaneously effective for both channels. The measurement of the Third-Order Intercept Point for an amplifier and the simulations of two different frequency oscillators outputting signals are two applied examples for coupling function.

- * The tracking function can produce 180 degree phase offset differential signals with same frequency and amplitude.
- * The phase function allows users to freely set phase parameters for both channels such as sine wave, cosine wave, and square wave signals.
- * The sum modulation function can sum up two signals into one and output this signal via one channel. One of the related applications is to sum up sine waveform and noise to execute speaker distortion tests.

J. FOUR METHODS TO OBTAIN ARBITRARY WAVEFORMS

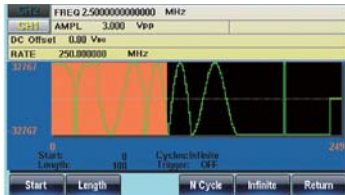

Front Panel Operation

Via single unit's panel, arbitrary waveforms can be selected, edited, stored, recalled, output, triggered from 66 built-in waveforms.

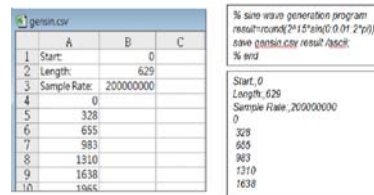

CSV File Upload

Support CSV file upload produced by MATLAB and Excel.



Direct Waveform Reconstruction

Collocate with GDS series digital oscilloscopes to retrieve waveforms and upload them to arbitrary generator to achieve direct waveform reconstruction.

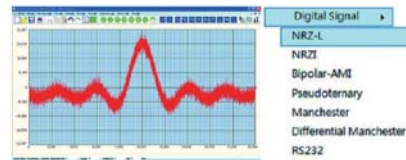

Arbitrary Waveform Editing PC Software

Use AWES to edit complex waveforms. The software supports waveform mathematical operation. The waveform series includes Uniform Noise, Gaussian Noise, Rayleigh Noise, various digital codes such as non zero code, Manchester and RS-232, etc.

K. FLEXIBLE ARBITRARY EDITING

Other Brand's ARB Operation



The Operation Mode Of "user-defined Retrieval Of Segmented Output" Increases Arbitrary Efficiency!

GW Instek ARB Operation

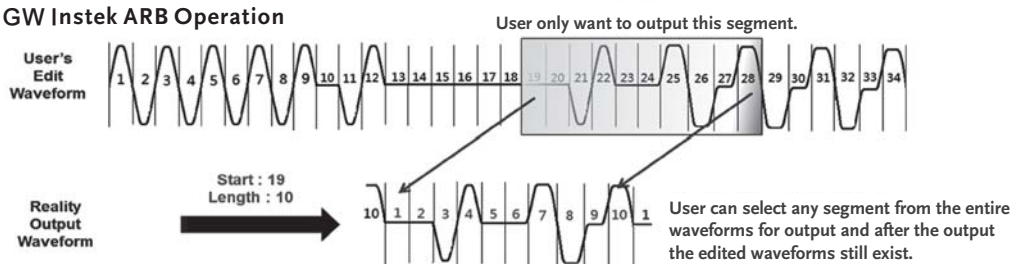

SPECIFICATIONS

	CH1 (Function With ARB)	CH2 (Function With ARB)	25MHz Pulse Generator	RF Generator (Function With ARB)	Power Amplifier	Modulation/Sweep/ Burst/Frequency Counter
MFG-2110	• 10MHz		•			
MFG-2120	• 20MHz		•			
MFG-2120MA	• 20MHz		•		•	•
MFG-2130M	• 30MHz		•			•
MFG-2160MF	• 60MHz		•	• 160MHz		•
MFG-2160MR	• 60MHz		•	• 320MHz		•
MFG-2230M	• 30MHz	• 30MHz	•			•
MFG-2260M	• 60MHz	• 60MHz	•			•
MFG-2260MFA	• 60MHz	• 60MHz	•	• 160MHz	•	•
MFG-2260MRA	• 60MHz	• 60MHz	•	• 320MHz	•	•

CH1/CH2

ARBITRARY FUNCTIONS	Arb Function Sample Rate Repetition Rate Waveform Length Amplitude Resolution Non-volatile Memory User-defined Output Section User-defined Output Marker Section Output Mode	Built-in 200 MSa/s 100MHz 16k points 14 bits 10sets 16k points(1) From point 2 ~ 16384 (uerdefine) From point 2 ~ 16384 (uerdefine) 1~1048575 cycles or infinite mode
FREQUENCY CHARACTERISTICS	Range Resolution Accuracy Stability Aging Tolerance	Sine 60MHz(max) Square 25MHz(max) Triangle, Ramp 1MHz 1 μ Hz ± 20 ppm ± 1 ppm, per 1 year ≤ 1 μ Hz
OUTPUT CHARACTERISTICS (2)	Amplitude Range Accuracy Resolution Flatness Units	1mVpp to 10 Vpp (into 50 Ω) 2mVpp to 20 Vpp (open-circuit) $\pm 2\%$ of setting ± 1 mVpp(at 1 kHz/into 50 Ω without DC offset) 0.1mV or 4 digits $\pm 1\%$ (0.1dB) $\cong 1$ MHz ; $\pm 3\%$ (0.3dB) $\cong 50$ MHz ; $\pm 10\%$ (0.9dB) $\cong 160$ MHz ; $\pm 30\%$ (3dB) $\cong 320$ MHz (sinewave relative to 1 kHz/into 50 Ω) Vpp, Vrms, dBm
OFFSET	Range Accuracy	± 5 Vpk ac +dc (into 50 Ω) ; ± 10 Vpk ac +dc (Open circuit) 1% of setting + 5mV+ 0.5% of amplitude
WAVEFORM OUTPUT	Impedance Protection Ground Isolation	50 Ω typical (fixed); > 10M Ω (output disabled) Short-circuit protected;Overload relay automatically disables main output 42Vpk max
SYNC OUTPUT	Range Impedance Ground Isolation	TTL-compatible into>1k Ω 50 Ω standard 42Vpk max
SINE WAVE CHARACTERISTICS (3)	Harmonic Distortion Total Harmonic Distortion	-60 dBc DC~200kHz, Ampl>0.1 Vpp -55 dBc 200kHz~1 MHz, Ampl>0.1 Vpp ; -45 dBc 1MHz~10 MHz, Ampl>0.1Vpp ; -30 dBc 10MHz~320MHz, Ampl>0.1Vpp < 0.1% (Ampl>1Vpp) DC~100 kHz
SQUARE WAVE CHARACTERISTICS	Rise/Fall Time Overshoot Asymmetry Variable duty Cycle Jitter	<15ns <5% 1% of period +5 ns 0.01% to 99.99%(limited by the current frequency setting) 20ppm+500ps(4)
RAMP CHARACTERISTICS	Linearity Variable Symmetry	< 0.1% of peak output 0% ~ 100%
PULSE CHARACTERISTICS	Frequency Pulse Width Variable duty Cycle Overshoot Jitter	1uHz ~ 25MHz $\cong 20$ nS(limited by the current frequency setting) 0.01%~99.99%(limited by the current frequency setting) <5% 20ppm +500ps(4)

PULSE GENERATOR

PULSE GENERATOR	Amplitude Offset Frequency Pulse Width Variable duty Cycle Leading and Trailing Edge Time(5) Overshoot Jitter	1mVpp ~ 2.5 Vpp (into 50 Ω) 2mVpp ~ 5 Vpp (open-circuit) ± 1 Vpk ac +dc (into 50 Ω) ± 2 Vpk ac +dc (Open circuit) 1uHz~25MHz 20nS~999.9ks(limited by the current frequency setting) 0.01%~99.99%(limited by the current frequency setting) 10nS~ 20S(1ns resolution) (limited by the current frequency and pulse width settings) <5% 100ppm +500ps(4)
------------------------	--	--

SPECIFICATIONS

RF GENERATOR		
	Waveforms Amplitude (into 50Ω) Offset Frequency	Sine, Square, Ramp, Pulse, Noise, ARB 1mVpp to 2 Vpp (MFG-2XXXMF); 1mVpp to 1 Vpp (MFG-2XXXMR) ±1 Vpk ac +dc (into 50Ω); ±2Vpk ac +dc (Open circuit) 1uHz~160MHz(MFG-2XXXMF); 1uHz~320MHz(MFG-2XXXMR)
MODULATION/ SWEEP	Modulation Type Sweep Type Source	AM,FM,PM,FSK,PWM (The detail same as CH1 modulation specification) Frequency INT/EXT(INT only for AM,FM,PM, PWM)
PSK	Carrier Waveforms Modulating Waveforms Internal Frequency Phase Range Source	Sine, Square, Triangle, Ramp, Pulse 50% duty cycle square 2 mHz to 1 MHz 0°~360.0° Internal/External
ASK	Carrier Waveforms Modulating Waveforms Internal Frequency Amplitude Range Source	Sine, Square, Triangle, Ramp, Pulse 50% duty cycle square 2 mHz to 1 MHz 0%~100.0% Internal/External
ARB function	Sample Rate Waveform Length Amplitude Resolution User-defined output section Jitter	200 MSa/s 16k points 14 bits From point 2~16384 (optional) 20ppm +5ns
POWER AMPLIFIER		
POWER AMPLIFIER	Input Impedance Input Voltage Working Mode Gain Output Power (RL=8Ω) Output Voltage Output Current Rise/Fall Time Full Power Bandwidth Overshoot Total Harmonic Ddistortion Ground Isolation	10KΩ 1.25Vpmax Constant Voltage 20dB 20W(Square) 12.5Vpmax 1.6Amax <2.5uS DC-100KHz 5% < 0.1% (Ampl>1Vpp); 20Hz~20 kHz 42Vpk max
ADVANCED FUNCTIONS		
AM MODULATION	Carrier Waveforms Modulating Waveforms Modulating Frequency Depth Source	Sine, Square, Triangle, Ramp, Pulse, Arb Sine, Square, Triangle, Upramp, Dnramp 2mHz ~ 20kHz (Int) DC ~ 20kHz (Ext) 0% ~ 120.0% Internal / External
FM MODULATION	Carrier Waveforms Modulating Waveforms Modulating Frequency Peak Deviation Source	Sine, Square, Triangle, Ramp Sine, Square, Triangle, Upramp, Dnramp 2mHz ~ 20kHz (Int) DC ~ 20kHz (Ext) DC to max frequency Internal / External
PM	Carrier Waveforms Modulating Waveforms Modulation Frequency Phase Deviation Source	Sine, Square, Triangle, Ramp Sine, Square, Triangle, Upramp, Dnramp 2mHz ~ 20kHz (Int) DC ~ 20kHz (Ext) 0° ~ 360.0° Internal / External
SUM	Carrier Waveforms Modulating Waveforms Modulation Frequency SUM Depth Source	Sine, Square, Triangle, Ramp Sine, Square, Triangle, Upramp, Dnramp 2mHz ~ 20kHz (Int) DC ~ 20kHz (Ext) 0% ~ 100.0% Internal / External
PWM	Carrier Waveforms Modulating Waveforms Modulation Frequency Phase Deviation Source	Sine, Square, Triangle, Ramp Sine, Square, Triangle,Upramp, Dnramp 2mHz ~ 20kHz (Int) DC ~ 20kHz (Ext) 0% ~ 100.0% pulse width Internal / External
FSK	Carrier Waveforms Modulating Waveforms Internal Frequency Frequency Range Source	Sine, Square, Triangle, Ramp, Pulse 50% duty cycle square 2 mHz to 1 MHz 1 μHz to max frequency Internal / External
SWEEP	Waveforms Type Sweep Direction Start/Stop Freq Sweep Time Source Trigger Marker Source	Sine, Square, Triangle, Ramp Linear or Logarithmic Sweep up or sweep down 1uHz to max frequency 1ms to 500s Internal / External Single, External, Internal. Marker signal on falling edge (programmable) Internal / External
BURST	Waveforms Frequency Pulse Count Start/Stop Phase Internal Frequency Gate Source Trigger Source	Sine, Square, Triangle, Ramp 1uHz~Max Frequency 1~1000000 Cycles or infinite -360.0°~+360.0° 1 us~500 s External Trigger Single, External, Internal.

SPECIFICATIONS

TRIGGER DELAY	NCycle, Infinite	0s~100 s
EXTERNAL TRIGGER INPUT	Type Input Level Slope Pulse Width Input Impedance	For FSK, Burst, Sweep TTL Compatibility Rising or Falling(Selectable) >100ns 10k Ω , DC coupled
EXTERNAL MODULATION INPUT	Type Voltage Range Input Impedance Frequency Ground Isolation	For AM, FM, PM,SUM,PWM \pm 5V full scale 10k Ω DC to 20kHz 42Vpk max
TRIGGER OUTPUT	Type Level Pulse Width Maximum Rate Fan-out Impedance	For FSK,Burst, Sweep TTL Compatible into 50 Ω >450ns 1MHz \geq 4 TTL Load 50 Ω Typical
FREQUENCY COUNTER	Range Accuracy Time Base Resolution Input Impedance Sensitivity Ground Isolation	5Hz to 150MHz Time Base accuracy \pm 1 count \pm 20ppm (23 $^{\circ}$ C \pm 5 $^{\circ}$ C) The maximum resolution is:100nHz for 1Hz, 0.1Hz for 100MHz. 1k Ω /1pf 35mVrms ~ 30Vrms (5Hz to 150MHz) 42Vpk max
Dual Channel Function (CH1/CH2)	Phase Track Coupling Dsolink	-180 $^{\circ}$ ~180 $^{\circ}$ Synchronize phase CH2=CH1 Frequency(Ratio or Difference) Amplitude & DC Offset \checkmark
OTHER	Store/Recall Interface Display	10 Groups of Setting Memories LAN, USB 4.3 inch TFT LCD, 480 x 3 (RGB) x 272
GENERAL SPECIFICATIONS	Power Source Power Consumption Operating Environment Operating Altitude Pollution Degree Storage Temperature Dimensions & Weight	AC100~240V, 50~60Hz or AC100~120V, AC220~240V, 50~60Hz 30W or 80W(With power amplifier) Temperature to satisfy the specification : 18 ~ 28 $^{\circ}$ C ; Operating temperature : 0 ~ 40 $^{\circ}$ C ; Relative Humidity: \leq 80%, 0 ~ 40 $^{\circ}$ C, \leq 70%, 35 ~ 40 $^{\circ}$ C ; Installation category: CAT II 2000 Meters IEC 61010 degree 2, Indoor use -10~70 $^{\circ}$ C, Humidity: \leq 70% 266(W) x 107(H) x 293(D) mm ; Approx. 2.5kg

The specifications apply when the function generator is powered on for at least 30 minutes under +20 $^{\circ}$ C~+30 $^{\circ}$ C. Specifications subject to change without notice. MFG-2000GD1BH

- Note : 1. A total of ten waveforms can be stored. (Every waveform can be composed of a maximum of 16k points.)
2. Add 1/10th of output amplitude and offset specification per $^{\circ}$ C for operation outside of 0 $^{\circ}$ C to 28 $^{\circ}$ C range (1-year specification).
3. DC offset set to zero
4. Jitter specification for RF Generator: 20ppm +5ns
5. Only Pluse channel support

ORDERING INFORMATION

MFG-2110	10MHz Single Channel Arbitrary Function Generator with Pulse Generator
MFG-2120	20MHz Single Channel Arbitrary Function Generator with Pulse Generator
MFG-2120MA	20MHz Single Channel Arbitrary Function Generator with Pulse Generator, Modulation, Power Amplifier
MFG-2130M	30MHz Single Channel Arbitrary Function Generator with Pulse Generator, Modulation
MFG-2160MF	60MHz Single Channel Arbitrary Function Generator with Pulse Generator, Modulation, 160MHz RF Aignal Generator
MFG-2160MR	60MHz Single Channel Arbitrary Function Generator with Pulse Generator, Modulation, 320MHz RF Signal Generator
MFG-2230M	30MHz Dual Channel Arbitrary Function Generator with Pulse Generator, Modulation
MFG-2260M	60MHz Dual Channel Arbitrary Function Generator with Pulse Generator, Modulation
MFG-2260MFA	60MHz Dual Channel Arbitrary Function Generator with Pulse Generator, Modulation, 160MHz RF Signal Generator, Power Amplifier
MFG-2260MRA	60MHz Dual Channel Arbitrary Function Generator with Pulse Generator, Modulation, 320MHz RF Signal Generator, Power Amplifier

ACCESSORIES

	Quick Start Guide x 1, CD-ROM with MFG Software and User Manual x 1
GTL-110	BNC Cable x 1 (MFG-2110/2120/2120MA/2130M/2160MF/2160MR)
GTL-110	BNC Cable x 2 (MFG-2230M/2260M/2260MFA/2260MRA)

OPTIONAL ASSESSORIES

GTL-246	USB Type A to Type B cable
----------------	----------------------------

FREE DOWNLOAD

Arbitrary Waveform Editing Software

Global Headquarters

GOOD WILL INSTRUMENT CO., LTD.

No.7-1, Jhongsing Road, Tucheng Dist., New Taipei City 236, Taiwan
T +886-2-2268-0389 F +886-2-2268-0639
E-mail: marketing@goodwill.com.tw

China Subsidiary

GOOD WILL INSTRUMENT (SUZHOU) CO., LTD.

No. 521, Zhujiang Road, Snd, Suzhou Jiangsu 215011 China
T +86-512-6661-7177 F +86-512-6661-7277
E-mail: marketing@instek.com.cn

Malaysia Subsidiary

GOOD WILL INSTRUMENT (M) SDN. BHD.

No. 1-3-18, Elit Avenue, Jalan Mayang Pasir 3, 11950 Bayan Baru, Penang, Malaysia
T +604-6111122 F +604-6115225
E-mail: sales@goodwill.com.my

Europe Subsidiary

GOOD WILL INSTRUMENT EURO B.V.

De Run 5427A, 5504DG Veldhoven, THE NETHERLANDS
T +31(0)40-2557790 F +31(0)40-2541194

U.S.A. Subsidiary

INSTEK AMERICA CORP.

5198 Brooks Street Montclair, CA 91763, U.S.A.
T +1-909-399-3535 F +1-909-399-0819
E-mail: sales@instekamerica.com

Japan Subsidiary

TEXIO TECHNOLOGY CORPORATION.

7F Towa Fudosan Shin Yokohama Bldg., 2-18-13 Shin Yokohama, Kohoku-ku, Yokohama, Kanagawa, 222-0033 Japan
T +81-45-620-2305 F +81-45-534-7181
E-mail: info@texio.co.jp

Korea Subsidiary

GOOD WILL INSTRUMENT KOREA CO., LTD.

Room No.503, Gyeonginro 775 (Mullae-Dong 3Ga, Ace Hightech-City B/D 1Dong), Yeongduengpo-Gu, Seoul 150093, Korea.
T +82-2-3439-2205 F +82-2-3439-2207
E-mail : gwinstek@gwinstek.co.kr

GW INSTEK

Simply Reliable



www.gwinstek.com

www.facebook.com/GWInstek